

MAGIC TH2 *plus* MAGIC TH2 *plus* RM

ISDN, POTS & VoIP Telephone Hybrids

Hardware/Software Manual



MAGIC TH2*plus* & MAGIC TH2*plus* RM

ISDN, POTS & VoIP Telephone Hybrids

Hardware/Software Manual

To get automatically informed about the latest software, please register on our homepage:

<http://www.avt-nbg.de>

Please click on **Create an account** under the **Log In** section. Now you need to enter your name/company, a user name and a valid **email address**.

Please click on **Register** to receive your confirmation email which includes the link to activate your account.

With your account you can also download manuals and the latest software in the Download section of our website.

A publication of:

AVT Audio Video Technologies GmbH
Nordostpark 12
D-90411 Nuernberg
Telephone +49-911-5271-0
Telefax +49-911-5271-100

Printed in Germany, May.2013
© AVT Audio Video Technologies GmbH

All rights reserved. Reproduction in
whole or in parts is prohibited without
previous written consent of Audio Video
Technologies GmbH.

Subject to change.

Release date: (05.13)

Content

	INTRODUCTION	11
	SAFETY	13
	Introduction	13
	General Safety Requirements	13
	Conventions	14
1	CONSTRUCTION	15
2	SYSTEM DESCRIPTION	17
2.1	Functionality	17
3	PUTTING THE SYSTEM INTO OPERATION	19
3.1	Mounting	19
3.2	Connection to the mains voltage	19
3.3	Earthing of the system	20
3.4	Operating elements on the front side	20
3.5	Operating modes of the system	21
3.5.1	POTS operating mode	21
3.5.2	ISDN operating mode	23
3.5.3	LAN operating mode (VoIP option required)	24
3.6	Applications	25
3.6.1	MAGIC TH2plus with PC and Keypad control	25
3.6.2	MAGIC TH2plus with three PC workstations	26
4	OPERATION VIA DISPLAY AND KEYPAD	27
4.1	Basic configurations	27
4.1.1	Keypad lock	27
4.1.2	Setting the menu language	27
4.1.3	Configuration of the LAN interface	28
4.1.4	Line mode: POTS or ISDN	28
4.1.5	Audio interface: Analogue or digital	29
4.2	Working with the MAGIC TH2plus	30
4.2.1	Call out	30
4.2.2	Status display - Operation during a connection	30
4.2.3	Dropping a connection	31

4.2.4	Accepting a call	31
4.2.5	Two connections	31
4.3	Comfort functions	31
4.3.1	Redialling	31
4.3.2	Using the phone book	32
4.3.3	Working with Presets	32
4.3.4	Send DTMF tones	34
4.3.5	Lock lines	34
5	WINDOWS PC SOFTWARE	35
5.1	Hardware requirements	35
5.2	User Registration	35
5.3	Installing the Windows PC software	35
5.4	Software update from the internet	36
5.5	The MAGIC TH2plus main window	37
5.5.1	Operating elements	38
5.5.1.1	Menu button	38
5.5.1.2	Global function keys: DROP ALL, LOCK ALL	38
5.5.1.3	Caller data fields	38
5.5.1.4	Status keys: PRETALK, HOLD, ON AIR, DROP	39
5.5.1.5	Status key: HD Voice	40
5.5.1.6	Caller Screening	40
5.5.1.7	Telephone Book/Manual Dialing	41
5.5.1.8	Call Forwarding (currently only implemented for POTS & VoIP mode)	42
5.5.1.9	Level meter and control	42
5.5.1.10	AGC on/off button	43
5.5.1.11	Load Preset button	43
5.5.1.12	Reset DTMF button	43
5.5.1.13	Send DTMF tones	43
5.6	Menu File	44
5.6.1	Submenu System Settings	44
5.6.2	Submenu Exit	44
5.7	Menu Configuration	45
5.7.1	Submenu Control Interface	45
5.7.2	Submenu System	47
5.7.2.1	Operation Settings	47
5.7.2.1.1	Mode & Audio Line	47
5.7.2.1.2	HOLD Signal	51
5.7.2.1.3	Signal Processing	52
5.7.2.1.4	Database	53
5.7.2.1.5	DTMF Event Labels	54
5.7.2.1.6	Relay / TTL	55
5.7.2.2	System Settings	60
5.7.2.2.1	General	60
5.7.2.2.2	Line Interface	61
5.7.2.2.3	MSN	64

5.7.2.2.4	POTS Interface: PABX	65
5.7.2.2.5	POTS Interface: Outside Line	67
5.7.2.2.6	VoIP (LAN/SIP)	68
5.7.2.2.7	Audio Interface	70
5.7.2.2.8	LAN Interface	72
5.7.2.3	Quick Dials	74
5.7.2.4	Date and Time	75
5.7.2.5	Login	76
5.7.3	Submenu Presets	78
5.7.3.1	Manage Presets	78
5.7.3.2	Activation of a Preset	80
5.7.4	Submenu DTMF Settings (Option)	80
5.7.5	Submenu Local Settings	81
5.8	Menu Administration	83
5.8.1	Submenu Registration	83
5.8.2	Submenu File System	85
5.8.3	Submenu System Panel	86
5.8.4	Submenu Firmware Download	87
5.8.5	Submenu Factory Settings	88
5.9	Menu Extras	89
5.9.1	Submenu System Monitor	89
5.10	Menu About MAGIC TH2plus	92
6	OPTION: DTMF TONE ANALYSER	93
6.1	DTMF system functions	93
6.1.1	DTMF call initiation via the Audio inputs	93
6.2	DTMF PC Software functions	94
6.2.1	DTMF Modes	94
7	OPTION: MAGIC TH2PLUS KEYPAD	97
7.1	LCD Display	98
7.2	Keypad Functions	100
A1	MENU STRUCTURE	103
A1.1	System Settings - ISDN	104
A1.2	System Settings - POTS	106
A1.3	Operation Settings	109
A1.4	Presets	110
A1.5	Status information	111
A1.6	Login	112
A2	INTERFACES	113
A2.1	POTS, ISDN and LAN interfaces	114
A2.1.1	POTS 1 & 2 interfaces	114

A2.1.2	S0 interface	114
A2.1.3	LAN interface	115
A2.2	PRETALK interfaces	116
A2.2.1	HANDSET 1 & 2 interfaces	116
A2.2.2	PHONE 1 & 2 interfaces	116
A2.3	Audio interfaces	117
A2.3.1	Analogue Audio interface	117
A2.3.2	Digital AES/EBU Audio interface	117
A2.4	Control Interface	119
A2.4.1	LAN interface	119
A2.4.2	Keypad 1,2 interface	119
A2.4.3	TTL/RELAY interface	119
A2.5	Power supply interface	120
A3	TECHNICAL DATA MAGIC TH2PLUS	121
A4	TECHNICAL DATA MAGIC TH2PLUS KEYPAD	124
A4.1	Keypad	124
A4.2	LCD Display	125
A4.3	Power supply:	125
A5	GENERAL	126
A5.1	Order numbers	126
A5.2	Scope of delivery	127
A5.3	Declaration of conformity	127
A6	SERVICE INFORMATION	128
A6.1	Software Updates	128
A6.2	Support	128
A6.3	Repairs	128
	INDEX	129
	DECLARATION OF CONFORMITY	135

INTRODUCTION

The **MAGIC TH2plus** system allows the forwarding of telephone calls to analogue and digital Audio interfaces.

The connection to the telephone network can be established either via two analogue POTS interfaces or an ISDN interface or optionally via a LAN interface for Voice-over-IP.

To optimise the caller signal each caller line has implemented its own digital **Echo Canceller** (approx. up to 100 msec), **AGC** (Automatic Gain Control) and **Expander**.

The configuration of the system can be made via the **MAGIC TH2plus Windows PC Software** included in delivery or via the front keypad of the unit. Optionally, up to two **MAGIC TH2plus Keypads** can be connected to operate the telephone hybrid without a PC. **MAGIC TH2plus** also provides four **TTL inputs/outputs** and two **Relays** for external control.

With additional **MAGIC TH2plus PC Software Licences** up to three PC workstations can be implemented, e.g. for Screener - Presenter applications.

MAGIC TH2plus is available as 1/2 x 19" x 1RU system with external 12V power supply or as full 19" x 1RU system with integrated 230V power supply. **MAGIC TH2plus RM** (19" version) has additionally a coloured front keypad for an even more user-friendly operation.

S A F E T Y

Introduction

The unit described has been designed to the latest technical parameters and complies with all current national and international safety requirements. It operates on a high level of reliability because of long-term experience in development and constant and strict quality control in our company.

In case of normal operation the unit is safe.

However, some potential sources of danger for person, material and optimal operation remain - especially if daily routine and technical errors coincide.

This manual therefore contains basic safety instructions that must be observed during configuration and operation. It is essential that the user reads this manual before the system is used and that a current version of the manual is always kept close to the equipment.

General Safety Requirements

To keep the technically unavoidable residual risk as low as possible, it is absolutely necessary to observe the following rules:

- Transport, storage and operation of the unit must be under the permissible conditions only.
- Installation, configuration and disassembly must be carried out only by trained personnel on the basis of the respective documentation.
- The unit must be operated by competent and authorised users only.
- The unit must be operated in good working order only.
- Any conversions or alterations to the unit or to parts of the unit (including software) must be carried out by trained personnel authorised by the manufacturer.
Any conversions or alterations carried out by other persons lead to a complete exemption of liability.
- Only qualified personnel is authorised to remove or override safety measures and to carry out the maintenance of the system.
- External software is used at one's own risk. Use of external software can affect the operation of the system.
- Use only tested and virus-free data carriers.

Conventions

In this manual, the following conventions are used as text markers:

Emphasis: Product names or important terms

LCD Text: Labelling on the front display of the system

PC Text: Labelling in the PC software

TIP

The symbol **TIP** labels information which facilitates the operation of the system in its daily use.

NOTE

The symbol **NOTE** labels general notes to observe.

ATTENTION



The symbol **ATTENTION** labels very important advice that is absolutely to observe. In case of non-observance disfunctions and even system errors are possible.

1 CONSTRUCTION

The functions of the **MAGIC TH2plus** are implemented in a single unit. The system is designed for mounting in a half 19" rack (1 U).

Optionally, a dual mounting kit is available (**MAGIC TH2plus DUAL 19" Mounting Kit** ID: 802002) for installing two **MAGIC TH2plus** systems next to each other.

FIG. 1 FRONT VIEW: MAGIC TH2PLUS TELEPHONE HYBRID



MAGIC TH2plus RM has full 19" design (1 U) with an integrated power supply and provides a coloured keypad.

FIG. 2 FRONT VIEW MAGIC TH2PLUS RM TELEPHONE HYBRID



2 SYSTEM DESCRIPTION

The functional elements of the system are pictured in Fig. 3.

FIG. 3 FUNCTIONAL ELEMENTS OF MAGIC TH2PLUS

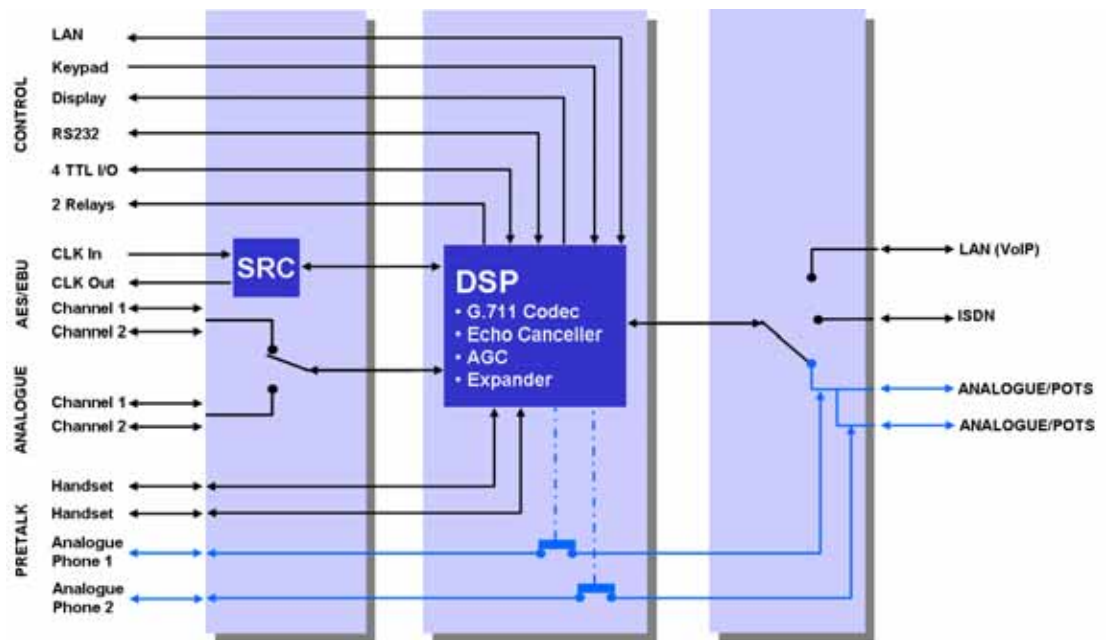

2.1

Functionality

The *MAGIC TH2plus* system incorporates two *POTS* interfaces, an *ISDN* interface and a *LAN* interface. The operating mode can be set with the help of the Windows PC Software or the front keypad and display. In each operating mode two independent telephone hybrids are available within one system (channel 1 and channel 2).

The complete signal processing is taken over by a digital *signal processor*. In this way the following functions are carried out:

- G.711 Audio encoding and decoding
- two independent *Echo Cancellers* for each line
- two independent *AGCs* (Automatic Gain Control)
- two independent *Expanders* (to suppress spurious signals)
- control of the complete system (Keypad, Display, Relay, TTL, RS232, LAN)

As *ON AIR* Audio inputs/outputs two independent analogue or digital Audio interfaces (digital: one AES/EBU interface) are available. If the AES/EBU interface is selected, both channels are multiplexed together (right/left chan-

nel). The inputs have separate digital Sample Rate Converters (SRC). For synchronisation with an external clock a clock input and a clock output are available.

Two separate **PRETALK** interfaces are available in all three operating modes. Two **Telephone Handsets** or **Headsets** (Options: ID: 802003/802004) can be connected for Pretalk. In the POTS operating mode you can connect two standard **POTS Telephones** for dialling and Pretalk.

The advantage of a handset/headset over a POTS Telephone is the possibility to switch between **ON AIR** and **PRETALK** anytime. With a telephone connected to the hybrid, it is only possible after the caller has been switched to **ON AIR** and if the telephone has not been hung up.

MAGIC TH2plus can be operated primarily via the **front keypad** and the illuminated **display**.

The configuration and operation is especially comfortable via the **MAGIC TH2plus Software** (see CHAPTER 5) included in delivery, which communicates with the system via the LAN interface. You can install up to three PC workplaces (additional **MAGIC TH2plus Software Licences** required, ID: 430396).

Most basic operating functions like accepting a call, dropping a connection and establishing a connection with a pre-programmed number can be carried out via four programmable **TTL contacts**. Two **relays** are available for status indication.

Additionally, the operation can be carried out via up to two **MAGIC TH2 Keypads** (see CHAPTER 7) which can be connected to the RS232 interface.

3 PUTTING THE SYSTEM INTO OPERATION

3.1 Mounting

With its dimensions (W × H × D) of 220 mm × 44,5 mm (1 U) × 220 mm the **MAGIC TH2plus** system can be either used as desktop device or mounted in a 19 inch rack. Corresponding 19" mounting brackets are included in delivery. Optionally, a mounting kit (ID: 802002) is available to implement two **MAGIC TH2plus** next to each other¹.

When mounting the unit please keep in mind that the bending radius of the cables is always greater than the minimum allowed value.

When the **MAGIC TH2plus** Telephone Hybrid is installed, please make sure that there is sufficient air ventilation: It is recommended to keep a spacing of ca. 3 cm from the openings. In general, the ambient temperature of the system should be within the range of +5°C and +45°C. These limits are especially to observe if the system is inserted in a rack. The systems works without ventilation.

TIP

The system temperature can be indicated on the display (**Menu Status Information** (see CHAPTER A1.5, Page 111))

During operation air humidity must range between 5% and 85%.

ATTENTION Incorrect ambient temperature and humidity can cause functional deficiencies.



Operation outside the threshold values indicated above leads to a loss of warranty claim.

3.2 Connection to the mains voltage

The system can be operated with mains voltage in the range of 90 V and 253 V via the external power supply adapter included in delivery. The mains frequency can range from 45 Hz to 65 Hz. The maximum power consumption is 15W. The rack must be earthed according to the VDE Regulations. This can be carried out via the earthing screw on the back side of the unit.

After plugging in the external power supply adapter (**MAGIC TH2plus**) or using the ON/OFF switch (**MAGIC TH2plus RM**), the unit boots in a few seconds. In standby mode the level meter/status display is shown on the display.

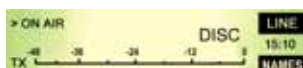

¹ In this way, you can also combine the MAGIC TH2plus with the products MAGIC DC7 XIP and MAGIC AC1 XIP.

3.3 Earthing of the system

For EMC reasons an earthing via the earthing screw of the system must be carried out in either case.

ATTENTION Earthing



A lacking earthing can cause functional deficiencies within the unit.

3.4 Operating elements on the front side

The system has an illuminated graphical display with a resolution of 160 x 32 Pixels and 21 operating buttons.

On the right next to the display there are two softkeys whose current functions are indicated on the display. In the middle there are two buttons for navigation (selection upwards/downwards), two buttons for accepting/dropping calls as well as an OK button. The numerical pad supports in addition to the numerals 0...9 also the '*' and '#' button. For entering text the numerical pad can also be used as a normal keypad.

The operation is similar to standard mobile phones.

FIG. 4 OPERATING ELEMENTS ON THE MAGIC TH2PLUS FRONT SIDE

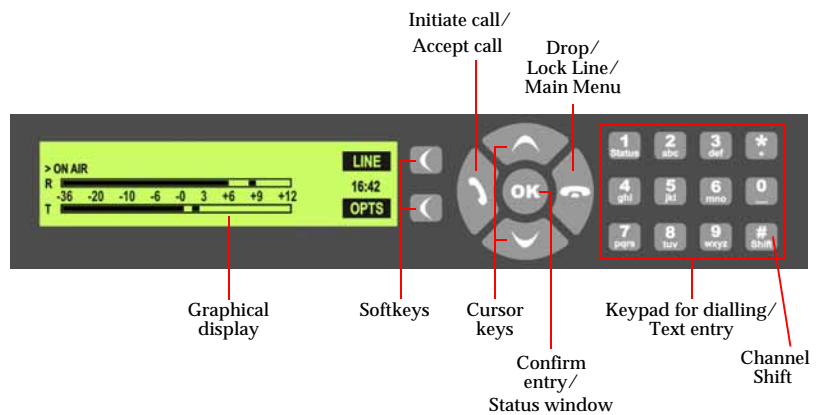
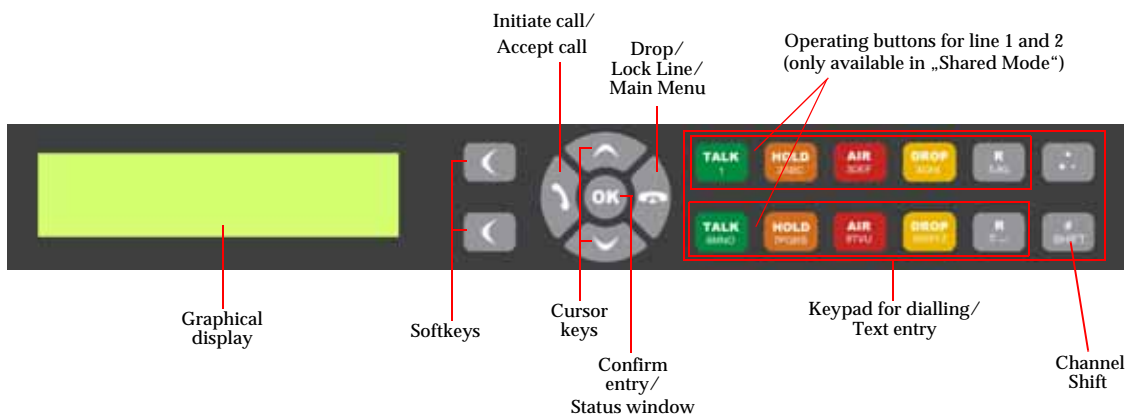

FIG. 5 OPERATING ELEMENTS ON THE MAGIC TH2PLUS RM FRONT SIDE



3.5 Operating modes of the system

The following figures show the system in the different operating modes and their respective cablings.

3.5.1 POTS operating mode

ATTENTION Earthing



If the POTS interfaces are in operation, the system must be earthed via earthing screw for EMC reasons. If the earthing is not carried out, the Audio signal can be faulty on the caller's side (humming).

The minimal wiring for the operation with an analogue telephone line is pictured in Fig. 6. Via the PHONE Interfaces up to two POTS telephones can be connected for PRETALK if required.

ATTENTION Connection of a POTS Telephone



Please note that the **PHONE** interfaces are implemented as **6-pole** Western sockets. Standard telephones with 4-pole Western connectors must **not** be used because otherwise the contacts in the socket will be destroyed.

FIG. 6 MINIMUM WIRING IN POTS OPERATING MODE

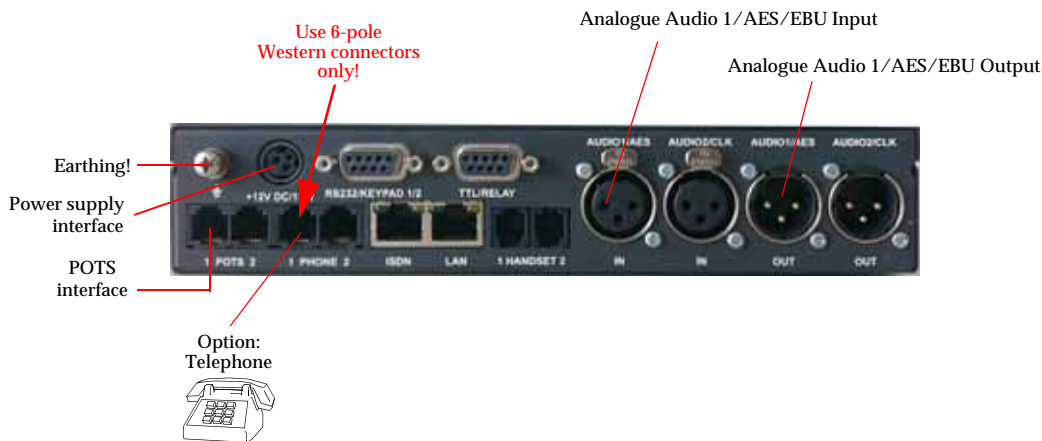

The maximum wiring with all options is shown in Fig. 7. The LAN interface allows the connection with a PC with **MAGIC TH2plus Software**. In total, three PCs with **MAGIC TH2plus Software** can access the system. Via the RS232 interface you can connect two **MAGIC TH2plus Keypads**.

FIG. 7 MAXIMUM WIRING IN POTS OPERATING MODE

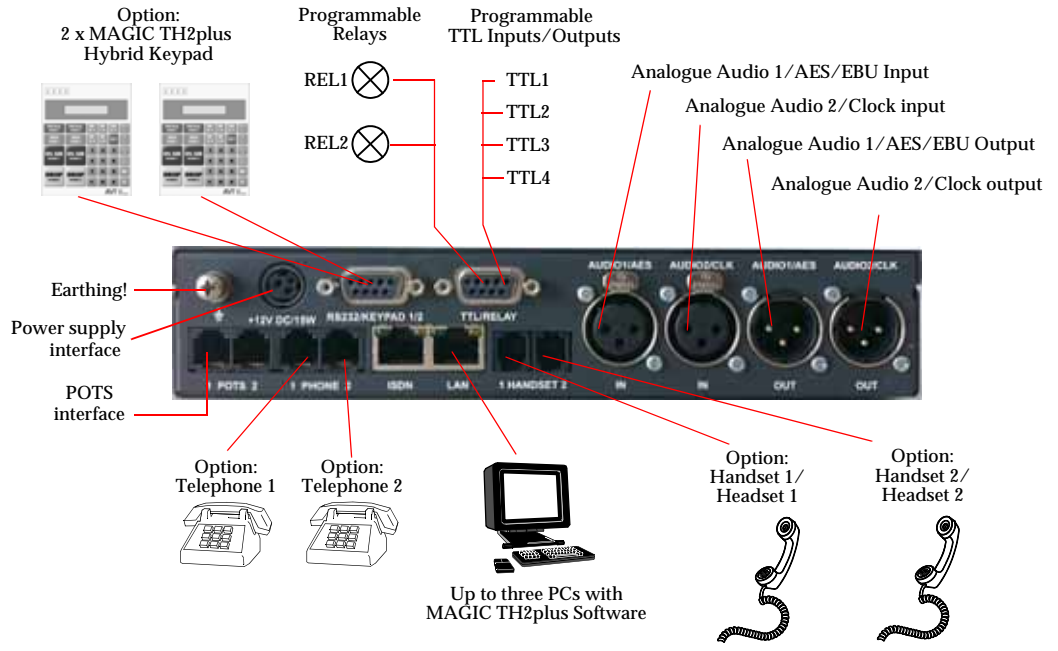

3.5.2 ISDN operating mode

In the ISDN operating mode, up to two handsets or headsets can be connected for PRETALK. The use of a POTS Telephone is not possible in this operating mode.

FIG. 8 MINIMUM WIRING IN ISDN OPERATING MODE

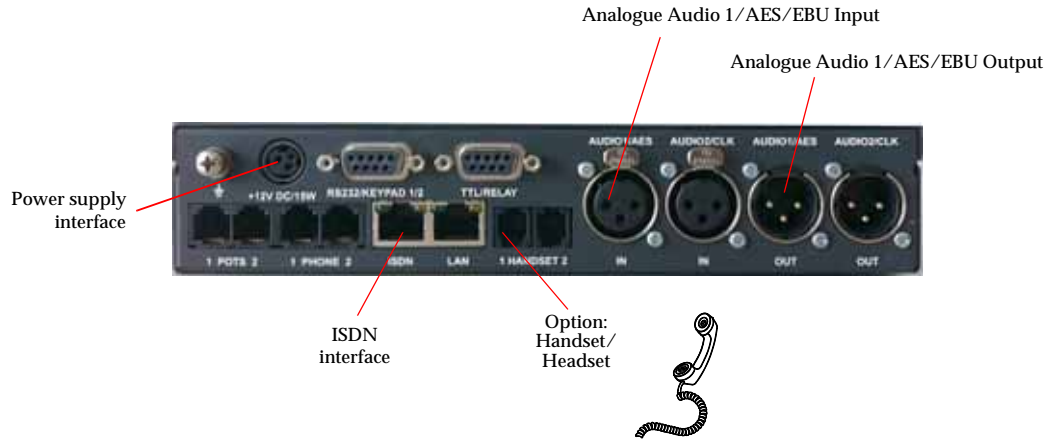

The maximum wiring with all options is shown in Fig. 9. Instead of the operation via the front keypad, the system can also be operated with the use of up to three PC with **MAGIC TH2plus Software** and up to two **MAGIC TH2plus Keypads** connected to the RS232 interface.

FIG. 9 MAXIMUM WIRING IN ISDN OPERATING MODE

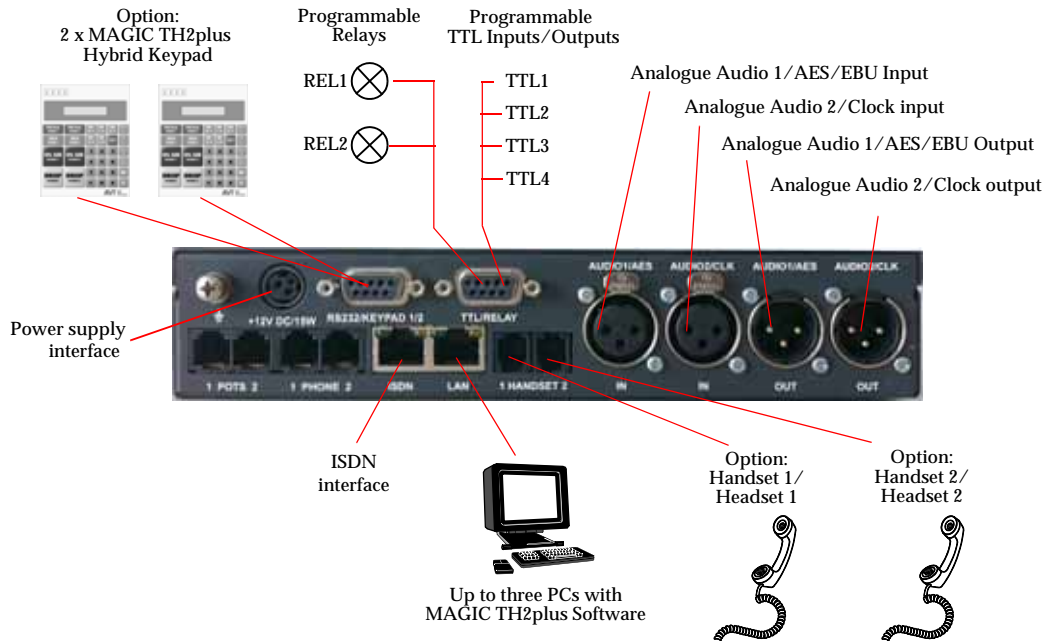

3.5.3 LAN operating mode (VoIP option required)

With the Software Option **Extension for Voice over IP** (ID: 430399) the system can be used as Voice-over-IP Telephone Hybrid for two callers using the LAN interface. Up to two handsets or headsets can be connected for PRETALK. The use of a POTS Telephone is not possible in this operating mode.

FIG. 10 MINIMUM WIRING IN LAN OPERATING MODE

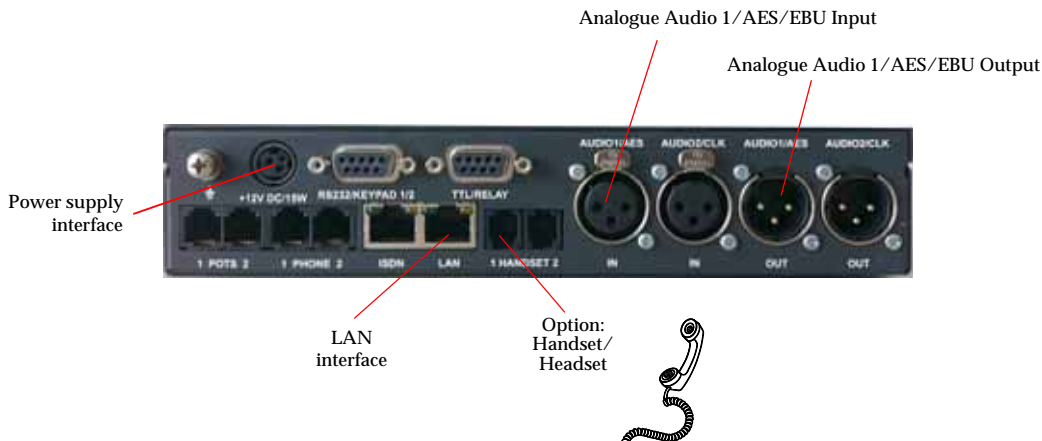

The maximum wiring with all options is shown in Fig. 9. Instead of the operation via the front keypad, the system can also be operated with the use of up to three PC with **MAGIC TH2plus Software** and up to two **MAGIC TH2plus Keypads** connected to the RS232 interface.

FIG. 11 MAXIMUM WIRING IN ISDN OPERATING MODE

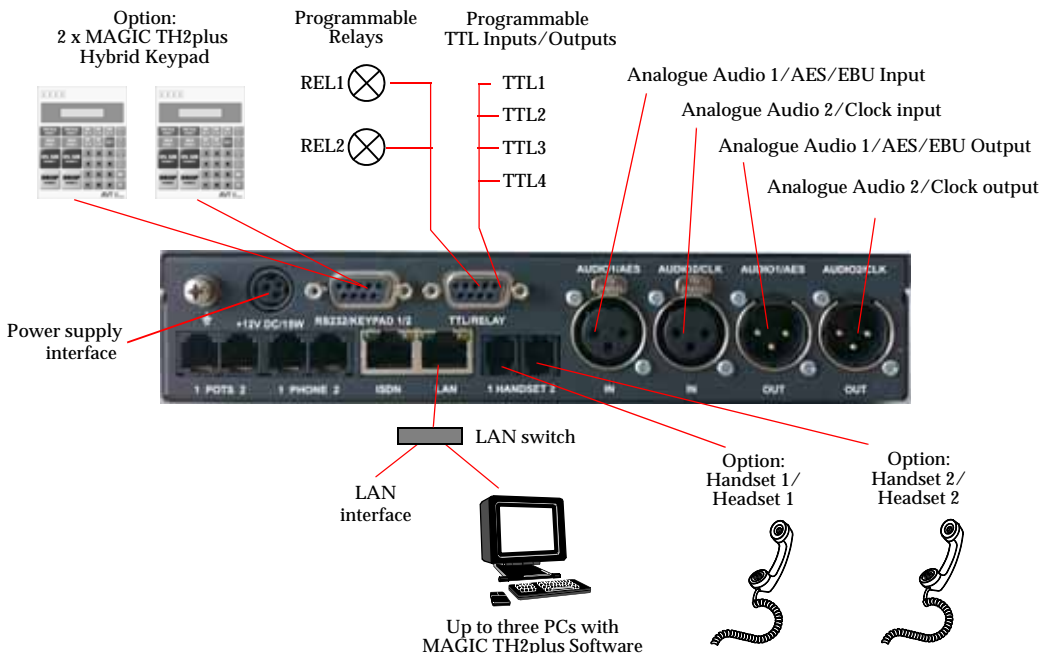

3.6 Applications

Below you will find some example applications with **MAGIC TH2plus**.

3.6.1 MAGIC TH2plus with PC and Keypad control

In the following drawing you can see **MAGIC TH2plus** controlled with a PC connected via LAN and the MAGIC TH2plus PC Software. A second workplace can access the system via a **MAGIC TH2plus** Keypad that is directly connected to the telephone hybrid. Both users have their own Pretalk lines. The Screener uses a headset that is directly connected to the **MAGIC TH2plus**. The Presenter's Pretalk line is implemented via the mixing console. In the conference mode the ON AIR caller signals are available at the Audio output as mixed signal. A recorded Audio signal or the On Air input Audio signal can be used as Hold Signal.

FIG. 12 APPLICATION: PC AND KEYPAD CONTROL

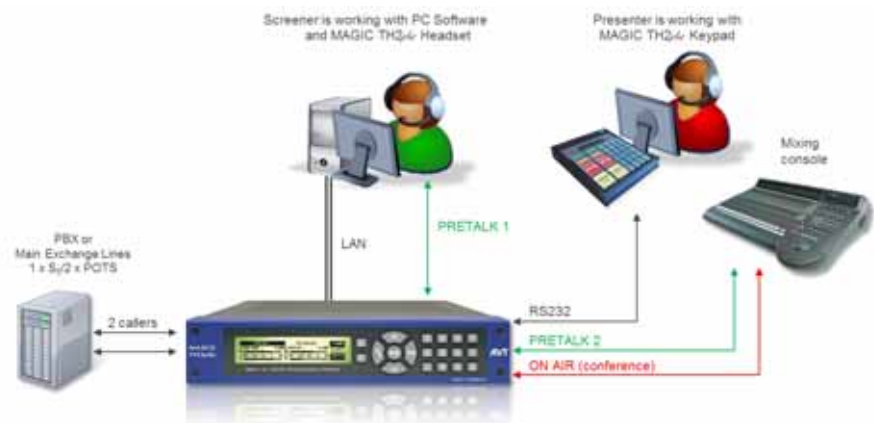

3.6.2 MAGIC TH2plus with three PC workstations

In the picture below **MAGIC TH2plus** is controlled via three PC workstations which are connected via LAN with the telephone hybrid. A caller line is automatically locked for the other users if one user works with that line. A caller in Hold status is available to all users. Each workplace has its own Pretalk line. Two Pretalk lines are implemented by connecting two headsets - one for the Producer and one for the Presenter - to the **MAGIC TH2plus** Telephone Hybrid. The Screener receives the Audio signals via Pretalk Streaming and uses a USB headset. The On Air caller signals are available at two different On Air Audio lines (Two-Faders operating mode). Both a recorded Audio signal or the On Air 1 Audio input signal can be configured as Hold Signal.

FIG. 13 APPLICATION: THREE PC WORKSTATIONS

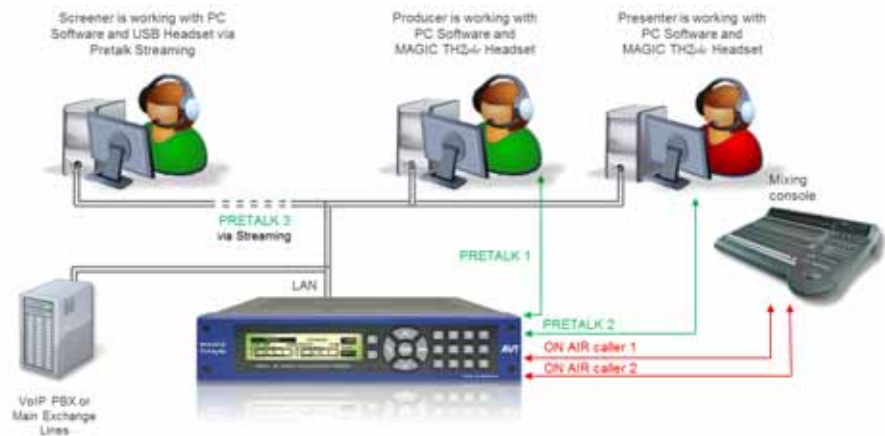

4 OPERATION VIA DISPLAY AND KEYPAD

In this chapter all significant settings to operate the **MAGIC TH2plus** system are explained. An overview of the menu structure can be found in the annex under CHAPTER A1.

All configurations can also be set comfortably via the **MAGIC TH2plus Software** included in delivery.

NOTE

For details concerning most functions please see CHAPTER 5 of the software description.

4.1

Basic configurations

Below, some specific basic configurations of the **MAGIC TH2plus** are described in detail.

NOTE

All menus can be reached directly via a **Quick Menu** key sequence. Each menu item is marked with a numeral in the upper left corner (in the example on the left it is 3). To get from the main menu directly to a specific menu, please enter the key sequence **Menu <Digit> <Digit>**, in which <Digit> marks the respective reference number of the menu. Please notice that the reference number can change in accordance with the configuration.

Menu reference number



4.1.1

Keypad lock

To avoid that keys are pressed unintentionally, you can activate a keypad lock. For activation please press the **Menu** key followed by the ***** key. If the keypad lock is activated, the display illumination is switched off immediately.

To deactivate the keypad lock, please enter again the key sequence **Menu ***.



4.1.2

Setting the menu language

In delivery status **English** is selected as standard menu language. In order to select **Deutsch** as menu language, please follow the instructions below:





NOTE

If you are not in the main menu, please press the  key first.

- First press the **Menu** softkey and select **System Settings** using the softkey **Select**.
- Press the cursor keys until the option **Language** is selected. Via the **Select** softkey you reach the options for the language. With the help of the cursor keys  and  please choose your language and press again **Select**.
- To get back to the main menu, please press the  key. Now you are asked if you want to **Save Settings**? Via the **Yes** softkey the settings are stored in the system.

4.1.3 Configuration of the LAN interface

To configure the LAN interface follow the instructions below:

- Press the **Menu** softkey.
- Please mark the option **System Settings** via the cursor keys  and  and press the **Select** softkey.
- Use the cursor keys  and  to get to the option **LAN settings** and press the **Select** softkey.
- To enter or change the IP Address of the system, mark the option **IP Address** and press the **Select** softkey.
- Now you can enter the correct IP Address via the numerical keypad.
- Press the  key to get back to the main menu. Now you are asked if you want to **Save Settings?**. Via the **Yes** softkey, the configuration is stored in the system.

TIP

You reach the settings for the **IP Address** directly via the key sequence: **Menu 141**.

The currently allocated IP address of the system can also be displayed by pressing the telephone button  on the front keypad of the system twice if currently no Audio connection is established.

NOTE







Maybe further settings which can also be found under the option **LAN settings** are necessary (e.g. **Sub-Net Mask**, standard: 255.255.255.000, and **Default Gateway**). In that case please contact your network administrator, who can tell you the correct settings.

4.1.4 Line mode: POTS or ISDN

To set the operating mode **POTS** or **ISDN** the following steps are necessary:

NOTE

If you are not in the main menu, please press the  key first.

- Press the **Menu** softkey.
- Please mark the option **System Settings** via the cursor keys  and  and press the **Select** softkey.
- Go to the option **Line Interface** using the cursor keys  and  and press the **Select** softkey.
- Select **Line Mode** and press the **Select** softkey again.
- Now you can enable the desired operating mode **ISDN** or **POTS** via the cursor keys  and  and the **Select** softkey.
- Press the  key to get back to the main menu. Now you are asked if you want to **Save Settings?**. Via the **Yes** softkey, the configuration is stored in the system.

TIP







You reach the settings for the **Line Mode** directly via the key sequence: **Menu 111**

4.1.5 Audio interface: Analogue or digital

The *MAGIC TH2plus* has analogue as well as digital Audio interfaces which can be adjusted separately. The digital *AES/EBU Audio input* has an implemented *Sample Rate Converter* to adjust the digital Audio clock to the line clock. Additionally, clock inputs and outputs are available. To configure the Audio interface please follow the instructions below:

NOTE

If you are not in the main menu please press the  key first.

- First press the **Menu** softkey and select **System Settings** via the softkey **Select**.
- With the use of the cursor keys  and  you reach the option **Audio**. Now press the **Select** Softkey.
- Please mark the option **Audio InPUT** or **Audio OutPut** using the cursor keys  and  and press again **Select**. Now the options **Analogue** and **Digital** are displayed.
- Select the desired option with the cursor keys  and  and by pressing the softkey **Select**.
- To get back to the main menu please press the  button. Now you are asked if you want to **Save Settings?** Via the softkey **Yes** the setting is stored permanently in the system.

TIP

You reach the settings for the **Audio Input** respectively **Audio Output** via the key sequence: **Menu 1 2 1** or **Menu 1 2 2**

4.2 Working with the MAGIC TH2plus

In the following paragraphs basic functions like call out, dropping a connection, accepting a call etc. are described in detail.

4.2.1 Call out

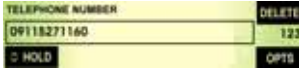

From the main menu just enter the phone number using the keys 0...9. After the first numeral the input field for the phone number is displayed automatically.

Via the **Delete** softkey wrong entries can be corrected.

With the use of the cursor keys \wedge and \vee the Audio line **ON AIR**, **HOLD** and - if configured - **PRETALK** can be selected. As soon as the called partner accepts the call, the incoming signal is available on the selected Audio line.

After entering the number the connection is established by pressing the telephone receiver button \hookrightarrow .

Via the **OPTS** (Options) softkey the dialled number can be saved in the phone book or stored as Quick dial number.

4.2.2 Status display - Operation during a connection

After pressing the telephone receiver button the subscriber is called and the status window is displayed.

If you have more than one connection, the displayed window is split in two - one for each available caller line.

An outgoing call is signalled by **CALL SETUP**. The dialled number (respectively the name if a phone book entry is selected) is displayed in the top line.

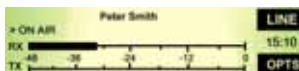

If the connection has been established, the level indication for the incoming signal (**RX**) and the outgoing signal (**TX**) is displayed.

The currently selected Audio line (in our example **>ON AIR**) is displayed above the level indication. The Audio line can be switched over by the use of the **Line** softkey. You just need to press the **Line** softkey several times until the desired Audio line is marked.

During the connection the volume of the caller signal can also be adjusted manually. Via the cursor keys \wedge and \vee the level can be increased or decreased. The current level is displayed in dB for a few seconds. Additionally, a small arrow on the display for the received level (**RX**) marks the current level for received calls.

TIP

Alternatively, you can activate the implemented **Automatic Gain Control**. You reach the settings for the AGC activation directly via the key sequence: **Menu 2 4 1**.

With the help of the **OPTS** (Options) softkey it is possible to save the displayed number and to switch directly to the phone book.

4.2.3 Dropping a connection

The connection can be dropped by pressing the telephone receiver button . If no other connection exists, the main menu is displayed after a few seconds.

4.2.4 Accepting a call

If the *MAGIC TH2plus* receives a call, the status window automatically displays the **Call In** signal.

The call is accepted directly via the telephone receiver button . The caller signal is displayed on the selected Audio line, which can be set via the **Line** softkey.

The call is rejected by pressing the telephone receiver button .

4.2.5 Two connections

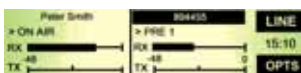
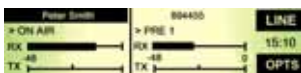

In both operating mode two separate telephone hybrids are available, which means you can establish two connections with different subscribers simultaneously.

To switch to the second channel please press the **Shift** key (**#**). The selected channel is displayed via an inverted display of the telephone number respectively the name. All further steps for operation are identical with the operation when there is only one caller. The channel can be switched anytime.



NOTE

If you want to drop a connection, please be sure that you select the right channel.

4.3 Comfort functions

4.3.1 Redialling



You reach the redialling function by pressing again the telephone receiver button  for the line on which currently no connection is established. In the list the subscribers recently called are displayed. In the input field **Search** you can search for a certain subscriber or select a subscriber from the list via the cursor keys  and .

For selecting the subscriber, please press again the telephone receiver button .

NOTE

To enter characters, please use the alphanumeric keypad. The desired character can be reached by pressing the respective key several times. For instance, to enter 'K' you must press the '5' key twice. Misentries can be corrected via the **Delete** softkey.

To switch between upper and lower case press the **SHIFT** key. The display changes from **ABC** to **abc**.

4.3.2 Using the phone book



The system incorporates a comfortable phone book function. The phone book can be reached from the main menu via the **Names** softkey.

In the input field **Search** you can search for a certain subscriber. As soon as you enter a character, the phone book entries in demand are retrieved.

Alternatively, you can select a subscriber from the list via the cursor keys **▲** and **▼**.

The following functions, which you can select via the **Select** softkey, are implemented by the **Opts.** (Options) softkey:

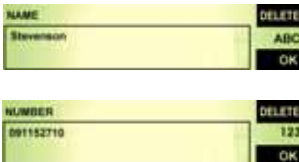

- **New Entry:** Via this function you can edit a new phone book entry. First enter the name and confirm your entry with **Ok**.

Afterwards, please enter the phone number of the subscriber, which you also confirm with **Ok**.
- **Edit:** Via this function you can edit already existing phone book entries.
- **View:** The selected phone book entry is displayed with name and phone number.
- **Delete Entry:** The selected phone book entry is deleted. For safety reasons you have to confirm that you really want to delete the entry.
- **Save as Quick dial:** Your 10 most important phone numbers can be programmed as Quick Dial under the numerical keys '0' ... '9'. Select the key which you want to use for programming the phone number.
To activate a Quick Dial, from the main menu just press the desired Quick Dial number for at least 3 seconds. The connection to the subscriber is established automatically.

4.3.3 Working with Presets

The **MAGIC TH2plus** differentiates between **system settings** and **operation settings**.

System settings are settings that do not change during normal operation such as e. g. language, date/time etc. These parameters can not be saved as presets since a configuration is usually only required when the system is put into operation.

Operation settings need to be reconfigured depending on the application. To easily recall recurring configurations you can store up to 10 Presets.

You reach the menu for the Presets by pressing the **menu** softkey once, the cursor key **▼** three times and by pressing the softkey **select** once as confirmation.

In the insert field **Presets** you can search for a certain Preset. As soon as you enter a character with the help of the alphanumerical keypad of the system, the corresponding entries of the Preset list are filtered out.

Alternatively, you can select a preset with the cursor keys **▲** and **▼** from the list.

If you now press the **Ok** button the selected Preset is loaded immediately.

By the softkey **OPTS** (Options) the following functions which you can select via the softkey **select** are realized:

- **load**: The selected Preset is loaded.
- **new**: With the help of this function you can create a new Preset. All current Operation Settings are stored as basic and can be adjusted afterwards.
- **Save**: The selected Preset is overwritten with the current Operation Settings. For safety reasons a confirmation is required
- **Delete**: The currently selected Preset is deleted. For safety reasons a confirmation is required.
- **Set Factory settings**: This function resets the system into the standard settings. Presets are not deleted.

NOTE

If the Preset has changed, you are asked if you want to **save settings** when you leave the Preset menu. Via the **yes** softkey the configuration is stored in the system. This Preset is loaded automatically by the system after the unit is connected with the power supply.

4.3.4 Send DTMF tones

If the fee-based option **DTMF** is activated in your system (see CHAPTER 6), you have the possibility analyse DTMF tones via the PC software. The sending of DTMF tones is a standard feature.

DTMF tones can be generated directly via the keypad of the system by pressing the numerical keys '0'...'9', '*', or '#' during a connection.

NOTE

Since the **Shift** key ('#') is used for switching between the two caller lines, it is necessary to keep the key pressed for 1 second to send the '#' DTMF tone.

4.3.5 Lock lines

To avoid further calls a caller line can be locked. A line can only be locked if no connection exists. In this case the callers hear the **Busy** signal. Outgoing calls are still possible if the switch respectively the Private Branch Exchange (PBX) is not already busy.

Please go to the status window by pressing the **Ok** button.

NOTE

If you are not in the main menu please press the  key first.

Now keep the key  pressed for one second. The display changes for the selected channel from **Disconnect** to **Locked**.

NOTE

To switch between the two caller lines please use the **Shift** key ('#').

By pressing the  key again, the selected channel is unlocked.

5 WINDOWS PC SOFTWARE

The configuration of the system can be carried out comfortably with the use of the Windows PC software included in delivery.

5.1 Hardware requirements

The PC used must meet the following minimum requirements:

- IBM PC AT, IBM PS/2 or 100% compatible
- Pentium Processor (> 1 GHz) recommended
- Windows XP/7
- 7 MB available hard disk space
- Screen resolution 800 x 600 Pixel
- LAN interface for PC control and configuration (alternatively RS232)
- Microsoft, IBM PS/2 or 100 % software compatible mouse

5.2 User Registration

To get always information about the latest software automatically, please register on our homepage:

<http://www.avt-nbg.de>

Go to **Create an account** under the **Log In** section and enter your name and email address. Define a user name and click on **Register**. You will receive a confirmation email that includes a link which allows you to activate your account.

5.3 Installing the Windows PC software

Please insert the CD included in delivery in your CD-ROM drive. The software automatically starts your internet browser. Possible safety warnings can be ignored for the moment. Press under **Install Software** the **MAGIC TH2plus** button. Subsequently, the setup program is executed.

Alternatively, the software can be installed directly from the CD. You can find the installation file **setup.exe** in the folder **SoftwareMAGIC TH2plus** on the CD.

Please follow the instructions of the installation routine.

After the installation please start the software by clicking on the **MAGIC TH2plus** symbol.

Connect the system via the LAN interface with your network. If you do not have a network you can also connect the unit to your PC directly via a so-called cross over network cable.

How to configure the LAN interface is described below (see CHAPTER 5.7.1, Page 45).

Alternatively, you can also use the RS232 interface and a serial 1:1 cable (only Pin 2 and Pin 3 are used, Pin 5=Ground) to connect your PC with the system.

5.4 Software update from the internet

Software updates can be downloaded from our homepage

<http://www.avt-nbg.de>

free of charge. Please go to our **Download** section and select **Software**. Under **MAGIC TH2plus** please download the file with the ID number **430409**. When the download is completed, execute setup and follow the instructions. In addition to the PC Software, the setup also includes the **Firmware** for the system. If it also has to be updated, the **MAGIC TH2plus** Software displays an error message when it is started. The instructions for a Firmware update are described later on (see CHAPTER 5.8.4, Page 87).

Operation via the Windows PC software

In the following chapters, all functions of the PC software are described in detail.

5.5

The MAGIC TH2plus main window

After starting the *MAGIC TH2plus Software*, the main window is displayed automatically (see Fig. 14).

The connection status between PC and system is displayed in the upper right corner of the window:



PC ONLINE: Connection is okay.



PC OFFLINE: Connection with PC is faulty

Following further status messages are possible:



PC ONLINE ALARM:
see *System Monitor*



WRONG APPLICATION:
You are using the wrong software, e.g. for *MAGIC AC1 XIP*.



BOOT MODE: There is no valid firmware on the system. Please execute a firmware download (see CHAPTER 5.8.4, Page 87).

NOTE

If the connection is faulty, please check the following points:

- External power supply of the system is plugged in (display available)
- LAN or serial 1:1 cable is connected with PC and system
- Correct IP Address and Port are selected (if LAN interface is used)
- COM port and correct baud rate are selected in the software (if RS232 interface is used)

FIG. 14 MAIN WINDOW OF THE MAGIC TH2PLUS SOFTWARE



5.5.1 Operating elements

5.5.1.1 Menu button



Via the **Menu** button the configuration dialogue is opened so that you can configure the **MAGIC TH2plus**.

5.5.1.2 Global function keys: DROP ALL, LOCK ALL



With the button **DROP ALL** you can drop all connection.



With the button **LOCK ALL** you can lock all caller lines. The DROP Button will be displayed as purple **LOCK** button. To unlock the lines, press the button a second time. To unlock only one caller line, press the **DROP/LOCK** button of the caller line.

NOTE

You can disable the lock function under **System Settings** → **Line Interface** → **General**. After enabling the option **Disable lock function**, the button **LOCK ALL** will not be displayed and you will also not be able to lock single lines.

In the **Shared** Mode the lock function is disabled by default (see Page 47).

5.5.1.3 Caller data fields

On the left side of each caller line the caller data fields are displayed. The following entry fields are shown:

- **Name**
- **First Name**
- Telephone **Number**

– **Information**

If you want to enter or change the caller information, just click on the desired field and enter the new information.



Additionally, the **Male/Female/?** button and the **Positive/Negative/Neutral/?** button are displayed next to the caller data fields. By clicking on the buttons you can change the setting.

NOTE

If a caller is already in the database and the telephone number is transmitted, you will see all available information immediately when a call is coming in.

5.5.1.4

Status keys: PRETALK, HOLD, ON AIR, DROP

Via the keys **PRETALK, HOLD, ON AIR** and **DROP** the line status is selected.

The button **PRETALK** switches the caller to Pretalk.



This button can only be used if you have assigned an Audio interface to **PRE TALK PC 1, 2** or/and **3** in the configuration under **Operation Settings** → **Mode & Audio** → **Audio Line Assignment**. Otherwise the button is displayed inverted and cannot be used.



If you use a POTS Telephone for Pretalk in the POTS operating mode, the Button **PRETALK** is replaced by the **Ext. Phone** button. To use a POTS Telephone for Pretalk, you must enable this feature under **System Settings** → **General** → **Using External Phone as Pretalk Interface (only available in POTS Mode)** (see CHAPTER 5.7.2.2.1, Page 60).



Via the **HOLD** key the caller is hold in line. The caller hears the Audio signal which is transmitted via the Audio input.

Instead of the program an Audio sequence stored previously in the system (**Recorded Hold Signal**) can be displayed (see CHAPTER 5.7.2.1.2).



By pressing the button **ON AIR** the caller is connected through via the corresponding Audio output.

If you have selected the **Two Faders Mode** or the **Shared Mode** (**ON AIR conference** not enabled) in the configuration under **Operation Settings** → **Mode & Audio** → **Mode**, the ON AIR buttons are displayed as ON AIR **1** and **2**.



Via the **DROP** key the connection to the caller can be dropped. If no connection exists the line is locked by pressing the key **DROP** a second time (**LOCK**). In this case the caller hears the **Busy** signal. The line is unlocked by pressing the key again. Outgoing calls are still possible in the locked status.



When there is an **incoming** call, **all** keys are displayed in yellow and blinking. Respectively, each of these keys can be selected. In this way, you can switch a caller directly **ON AIR** for instance.

In contrast to this, when there is an **outgoing** call, the keys **PRETALK**, **HOLD** and **ON AIR** are displayed yellow and static whereas the key **DROP** is displayed yellow and blinking. Only the **DROP** button can be selected.

5.5.1.5 **Status key: HD Voice**



If the fee-based **HD Voice Upgrade (ID: 430465)** has been activated and the system is used in the Voice-over-IP operating mode, this status key shows that the connection has been established with G.722 in 7-kHz quality.

5.5.1.6 **Caller Screening**



If you click on the **Assign** button which is displayed next to the telephone number of the caller, the **Select Caller** window is opened. The Assign button works only during incoming calls, outgoing calls and an existing connection.

FIG. 15 SELECT CALLER WINDOW



If there is already an existing database entry for the telephone number with which the connection is established, all available information will be displayed. To add or change information, please press the **Edit** button. The **Edit Caller Entry** window is displayed where you can edit the database entry.

Alternatively, you can also search the database for a last name, first name or a telephone number using the search field at the top of the **Select Caller** window. All matching entries are immediately displayed on the right side of the window. To view the details of an entry, just click on the corresponding name or number. To select the database entry for your current caller, please press the **Select** button.

To create a new entry, click on the **New** button. The **Edit Caller Entry** is opened where you can enter the caller details.

To delete the currently displayed entry, please press the **Delete** button.

5.5.1.7 Telephone Book/Manual Dialing

To open the Telephone Book you must click on the **PRETALK**, **HOLD** or **ON AIR** button of one of the caller lines when no connection is established.

The **Dialing** window is opened. Via this window, you can dial out manually or use an existing telephone book entry.

To dial out manually, use the numerical buttons and click on **CALL**. The **CALL** button is displayed in the colour of the Audio line (green = Pretalk, orange = Hold, red = ON AIR) on which the connection will be established (depends on which button you clicked to open the **Dialing** window).

FIG. 16 DIALING WINDOW



To search for a telephone book entry, enter the number or the name of the caller into the **Search** field. The matching entries are displayed in the middle of the window. You can select the desired entry with your mouse to be displayed on the left side.

FIG. 17 SEARCH TELEPHONE BOOK



To call the selected entry click on **CALL**. The **CALL** button is displayed in the colour of the Audio line (green = Pretalk, orange = Hold, red = ON AIR) on which the connection will be established (depends on which button you clicked to open the **Dialing** window)

To delete the selected entry, click on **Delete**.

To edit the selected entry, click on **Edit**.

To create a new entry, click on the **New** button. The **Edit Caller Entry** is opened where you can enter the caller details.

FIG. 18 EDIT CALLER ENTRY



Now you can enter **Name**, **First Name**, **Street**, **ZIP** (Postal Code) and **Town**. For each caller you can save up to three numbers. The labels for the number types can be defined under **Operation Settings** → **Database** → **Telephone Book**. You can assign the buttons **Male/Female/?** and **Positive/Negative/Neutral/?** to the caller and enter information in the **Information** field.

To save the entry, click on **OK**. To cancel the entry, click on **Cancel**.

POTS, VoIP

5.5.1.8

Call Forwarding (currently only implemented for POTS & VoIP mode)



With the call forwarding button, you can forward a call to any telephone number. Just press the call forwarding button, when a call is coming in or during an established connection. The **Dialing** window will be opened and you can enter a telephone number manually or select a number from the telephone book. Confirm your entry with the **Call** button. As soon as you drop the connection, the caller is forwarded to the desired telephone number.

NOTE

Before you drop the caller, you have the possibility to talk to the call forwarding destination.



If no connection is established, the call forwarding button is displayed inverted and cannot be used.

5.5.1.9

Level meter and control

The level of the transmitted signal (**TX**) as well as the (**RX**) of the received caller signal are displayed via separate level meters.

FIG. 19 LEVEL METER

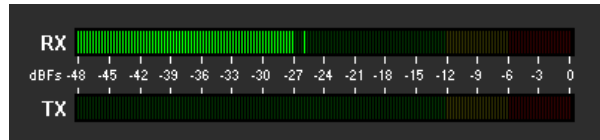

Additionally, the received level of the caller can be manually increased or decreased in the range of **-16dB** and **+16dB** separately for each caller line.

FIG. 20 LEVEL CONTROL

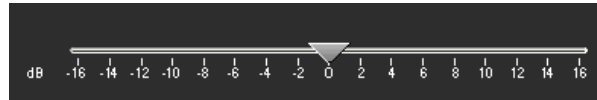

5.5.1.10 AGC on/off button



For each caller line you can switch on an Automatic Gain Control. This can be selected in the configuration under **System** → **Operation Settings** → **Signal Processing** or you simply use the **AGC** button next to the level control of each caller line.

NOTE

If the writing on the button **AGC** and the triangle  are displayed in red, the **Automatic Gain Control (AGC)** is activated.

5.5.1.11 Load Preset button



Via the **LOAD PRESET** button you can load a Preset.

5.5.1.12 Reset DTMF button



The **RESET DTMF** button is only displayed if the fee-based option **DTMF Tone Analyzer Plug-In (ID: 430200)** is available and if you have selected **Standard** or **Game Show** under **Configuration** → **DTMF Settings**. Further details you will find in CHAPTER 6, Page 93.

5.5.1.13 Send DTMF tones

To send DTMF tones to a partner please press the respective status key (**Hold**, **Pretalk** or **ON AIR**) and use the numerical pad, i.e. if the caller is currently ON AIR, press the **ON AIR** button. You can only send DTMF tones during a connection.

FIG. 21 SEND DTMF



5.6

Menu File

FIG. 22 MENU FILE

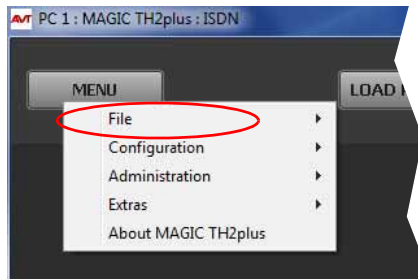

5.6.1

Submenu System Settings

Via the submenu **System Settings** you can import or export system settings.

With the selection **File** → **System Settings** → **Import** you can import a complete system configuration (all settings made under **System Settings: General, Line Interface, MSN, POTS interface: Outside Line, POTS Interface: PABX, VoIP, Audio Interface, LAN Interface and Quick Dials**) from a data carrier. The file extension is always **.TH2**.

With the selection **File** → **System Settings** → **Export** you can save your current system settings. You can select the memory location for the file.

5.6.2

Submenu Exit

Via the submenu **Exit** you exit the **MAGIC TH2plus** software.

5.7 Menu Configuration

FIG. 23 MENU CONFIGURATION

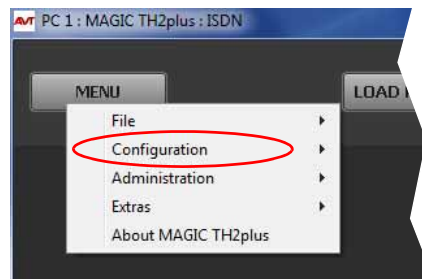

5.7.1 Submenu Control Interface

Preferably, the system is configured and operated via the LAN interface. Alternatively, you can also operate the system via the RS232 interface.

LAN

For controlling the system via the LAN interface please select **Interface** → **UDP**.

FIG. 24 LAN PARAMETERS

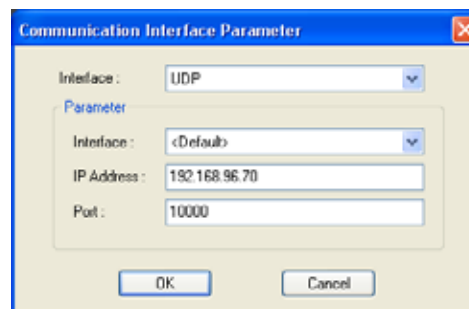

Under **Parameter** → **Interface** edit **<Default>**. If there should be more than one network interface card in your PC, select the desired one.

The standard **IP Address** of the system is **192.168.96.102** and the standard control **Port 10000**.

To enable a connection with your PC, you have to be in the same **subnet**. Therefore, please enter an IP address from your subnet¹ or activate **DHCP** (Dynamic Host Configuration Protocol) to get the correct settings automatically (if a DHCP Server is available).

To change the IP address on the front keypad of the system, press the softkey **Menu** → **system settings** → **LAN settings** → **IP Address**. Enter now the desired IP address. When entering manually you have to be sure that the IP address is not already used by another unit².

¹ In this way you can find out your own subnet: Under **Windows XP** click on **Start** → **Execute** Enter **cmd** in the command line. An entry window is displayed in which you must enter **ipconfig**. Your IP address is displayed (e.g. 192.168.12.35). Your subnet is accordingly 192.168.12.xxx.

Please enter the correct IP address of the system under **IP Address** and the correct Port under **Port**.

TIP

The currently allocated IP address of the system can be displayed by pressing the telephone button  on the front keypad of the system twice if currently no Audio connection is established.

RS232

If you want to use the RS232 interface, connect the serial RS232 interface via a 1:1 connecting cable with your PC. Please select now under **Interface** → **RS232**. Under **Parameter** → **Port** the **COM Port** of your PC, which is connected with the system and under **Mode** the desired baud rate (standard: **38400 Baud**).

FIG. 25 RS232 PARAMETER.

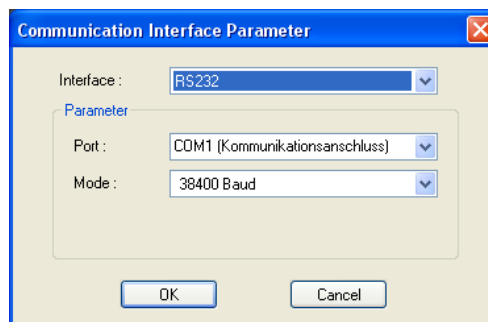

NOTE

Instead of the PC you can also connect the optional **MAGIC TH2plus Keypad** to the serial interface of the system (see CHAPTER 7, Page 97).

ATTENTION



If you connect your PC via RS232, the LAN interface of the **MAGIC TH2plus** will be disabled. In this way, you can only connect one PC to the system.

Control Interface List

If you want to manage several units with the PC Software or you want to connect to one system via different control ports, e.g. as PC 1 and PC 2, you can use the option **Control Interface List**.

To create a new list entry, press the **New** button. Please enter the settings for the LAN or RS232 parameters as described above. Additionally, you can enter a **Name** for the list entry. The new entry will be displayed as button in the main window of the **MAGIC TH2plus PC Software**, e.g. if you create an entry with the name PC 1, the corresponding button will be displayed.



² To check if the IP address is already used in the network, follow the instructions: Under **Windows XP** click on **Start** → **Execute....** Enter **cmd** in the command line. An entry window is displayed in which you must enter **ping xxx.xxx.xxx.xxx**. Whereas xxx stands for the IP address you want to check.

FIG. 26 CONTROL INTERFACE LIST PARAMETER

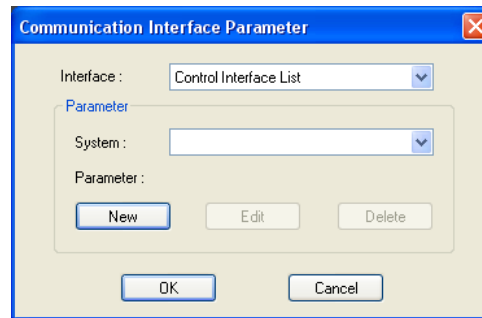

By the key **Edit** you can edit the currently selected entry. With **Delete** you can cancel the list entry.

5.7.2 Submenu System

Via the submenu **System** the system can be configured comfortably. It is distinguished between **System Settings**, which do not have to be changed during the operation and the **Operation Settings** for the current application.

5.7.2.1 Operation Settings

Operation Settings can be saved as Presets (see CHAPTER 5.7.3, Page 78).

5.7.2.1.1 Mode & Audio Line

Under **Mode & Audio Line** you can select the operating mode for the system, enable the conference mode for Pretalk and ON AIR and assign the Audio lines.

FIG. 27 MODE & AUDIO LINE

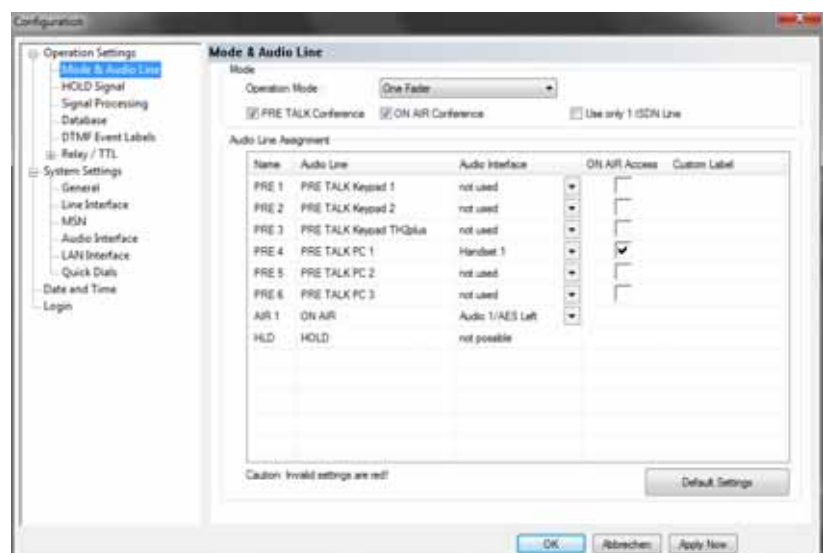

Mode

- Under **Operation Mode** you can select the following operating mode for the system:

- **One Fader:** Both ON AIR caller signals are available at one Audio output. You can define which Audio interfaces are used for the ON AIR line and the Pretalk lines.
- **Two Faders:** The ON AIR caller signals are available at separate Audio outputs (ON AIR 1 and ON AIR 2). You can define which Audio interfaces are used for the ON AIR and Pretalk lines.
- **Shared:** The system is operated exactly like the MAGIC TH2 i. e. one Pretalk line and either one common ON AIR line or two separate ON AIR lines (ON AIR 1 and ON AIR 2) are available.

FIG. 28 SHARED MODE

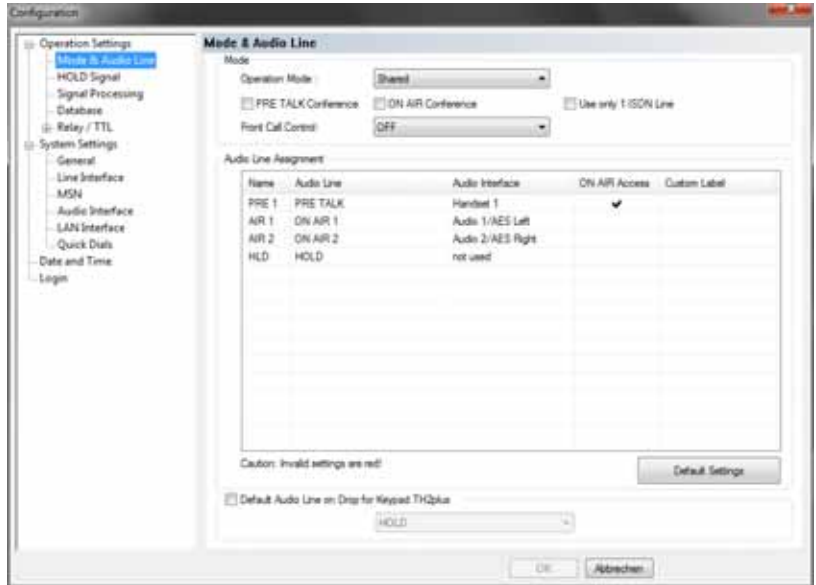

- The **Shared Mode** allows an operation of the system via the coloured front keypad keys of **MAGIC TH2plus RM** if you select **Front Call Control**. This function can also be used with **MAGIC TH2plus** but this system has no coloured keys.

FIG. 29 COLOURED FRONT KEYPAD MAGIC TH2PLUS RM



NOTE

If you select the **Shared Mode** and work with several PCs and Keypads, the caller lines will **not be locked** for the other users if one user works with the caller, e.g. switches him to Pretalk/ON AIR. This is only possible in the **One Fader** or **Two Faders Mode**.

- To allow Pretalk or/and ON AIR conferences, the options **PRE TALK Conference** or/and **ON AIR Conference** must be enabled. If you do not activate these options, only one caller is allowed to be in Pretalk or/and ON AIR at a time. As soon as a second caller is switched to Pretalk or ON AIR, the first caller is automatically switched to HOLD.
- If you want to use only one caller line, you can select the option **Use only 1 ISDN line/ Use only 1 POTS line/ Use only 1 VoIP line**. In this case, only one channel will be displayed in the Windows PC software.

FIG. 30 USE ONLY 1 LINE

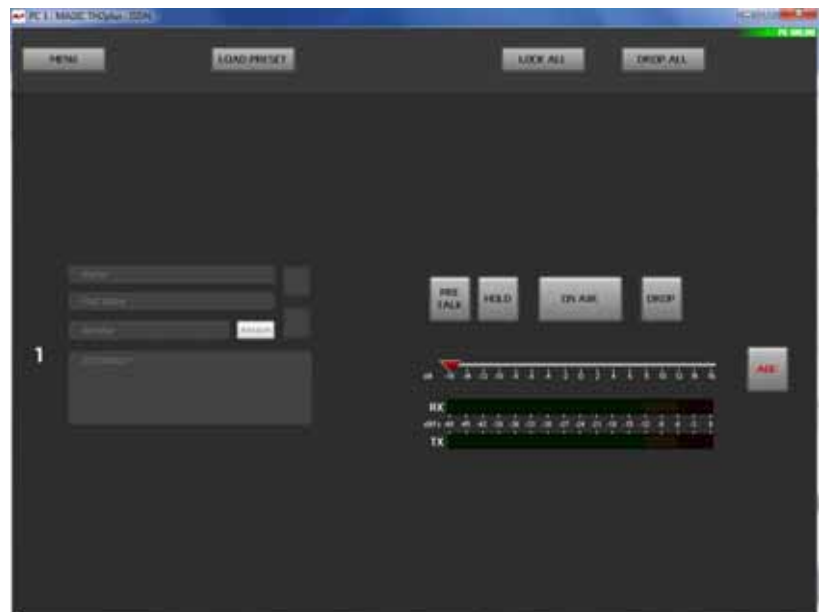

Audio Line Assignment

- Under **Audio Line Assignment** you can assign the Audio interfaces to the ON AIR and Pretalk lines.
- In the column **Name** you can see which name is displayed on the front display of **MAGIC TH2plus** if the corresponding Audio line has switched a caller to Pretalk or ON AIR.
- The column **Audio Line** shows the available Pretalk and ON AIR Audio lines. If a caller is switched to one of these Audio lines by a user, the other users who are working with the PC Software will see the corresponding name displayed on the Pretalk and ON AIR buttons.

Example: User 1 is working with the Audio line **PRETALK PC 1**. If he switches a caller to Pretalk, user 2 who is working with a second PC will see **PREATLK PC 1** displayed on the Pretalk button. On the front display of the system **PRE4** will be shown.

- In the column **Audio Interface** you can select which Audio interface is to be assigned to which Audio line. If you do not want to use an Audio line, select **Not used** in the column **Audio Interface**.
- Via the column **ON AIR Access** you can define if a user working with the corresponding Audio line can put a caller to ON AIR or not.

- If you want to assign a different name to the Audio line to be displayed in the PC Software, you can enter a new name under **Custom Label**.
- To select the default settings for your selected operating mode, please click on **Default Settings**. For safety reasons you must confirm that you really want to select the default settings.

5.7.2.1.2 HOLD Signal

The configuration of a HOLD signal can be done under **Hold Signal**.

FIG. 31 RECORDED HOLD SIGNAL

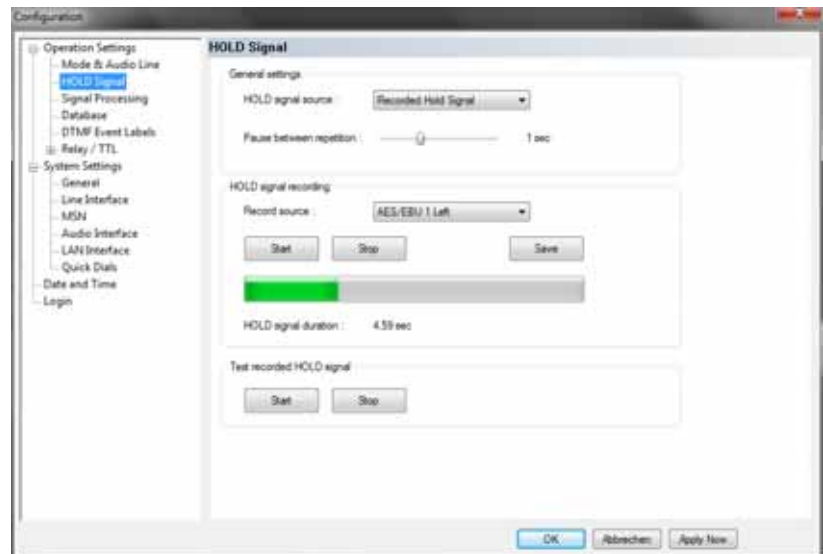

General settings

- Under the setting **HOLD signal source** you can select the **HOLD** signal that you want to use.

With the option **ON AIR** the signal which is transmitted via the **AUDIO 1** interface is used as **HOLD** signal.

If you select **Recorded Hold Signal**, the caller hears the Audio signal stored in the system. The signal is identical for both lines.

- With the use of the slide control **Pause between repetition** you can set the pause between the repetitions of the recorded signal. The pause time ranges from **0 to 3 sec**.

HOLD signal recording

- Under **Record source** you can select the Audio interface via which the HOLD signal is recorded.
- Via the button **Start** you start the recording. With **Stop** the recording is stopped. With **Save** the recorded signal is saved in the permanent memory (FLASH-EPROM) of the system.
- The duration of the recorded HOLD signal is displayed under **HOLD signal duration**. The maximum duration of a recorded signal is 16 seconds.

Test recorded HOLD signal

- To test the recorded signal it can be played back. The button **Start** starts the play-back of the recording and by **Stop** it is stopped.

5.7.2.1.3 Signal Processing

Under **Signal Processing** you can configure the **AGC** (Automatic Gain Control), the **Echo Canceller** as well as the **Expander**.

FIG. 32 SIGNAL PROCESSING

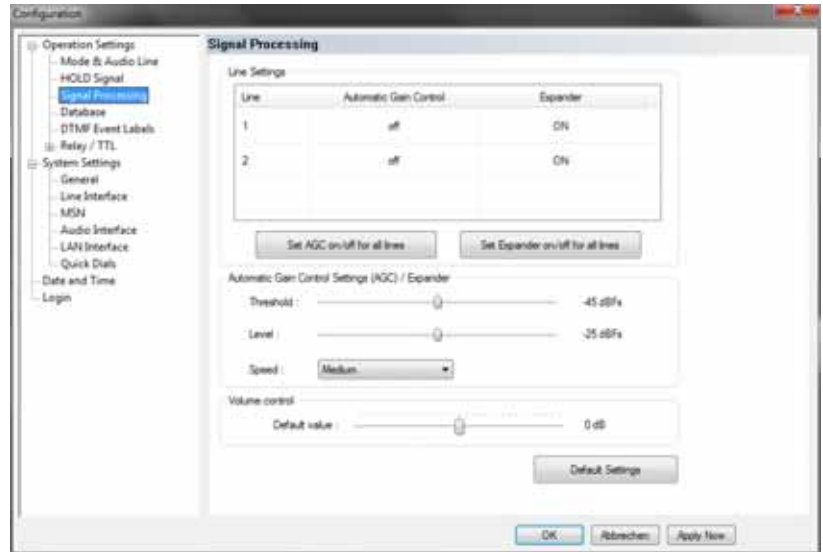

Line Settings

- A separate Automatic Gain Control (**AGC**) can be switched on for both channels.

ATTENTION



An Automatic Gain Control is reasonable if you do not have the possibility for Pretalk during which the level can be adjusted.

But: An AGC is no wizard. Extremely low callers cannot be boosted boundlessly. Extremely loud callers cannot be toned down boundlessly.

Please select the desired line with your mouse. To switch off the **AGC** select **Off**. To switch it on select **On**.

FIG. 33 CONFIGURATION AGC



Via the button **Set AGC on/off for all lines** you can switch on respectively switch off the **AGC** for all lines.

- An **Expander** tones down the caller signal automatically, if its level falls below a certain threshold value. The aim is to completely filter out background noises of callers who are not currently speaking.

To activate the **Expander** select the desired line with your mouse. To switch off the **Expander** select **Off**. To switch it on select **On**.

Via the button **Set Expander on/off for all lines** you can switch on respectively switch off the **Expander** for all lines.

Automatic Gain Control Settings (AGC)/Expander

The correct functioning of the **AGC** can be optimised via several parameters.

- **Threshold:** The **AGC** does not start before the signal exceeds the threshold value set here. The default setting is **-45 dBFs**.
- **Level:** The level set here corresponds to the average desired level. Please consider sufficient head room. The default setting is **-24 dBFs**.
- **Speed:** Depending on the desired speed of the level adjustment (**Slow**, **Medium** or **Fast**) you can adjust the setting of the AGC speed. The faster the AGC must work the more noticeable are the inconsistencies. If the selected speed is too slow, the caller signal is too low or too loud on average. The default setting is **Medium**.
- With the use of the key **Default Settings** the default settings named above can be configured and the **Expander** can be activated.

Volume Control

Under **Volume Control** you can select the **Default Value** for the volume control within the range of **-16 ... +16 dB**.

5.7.2.1.4

Database

MAGIC TH2plus can work with a caller database where you can save telephone numbers and caller information. If a telephone number is stored in the database, the caller information, such as e.g. the caller's name, will be immediately displayed when a call is coming in and the number is transmitted.

FIG. 34 DATABASE

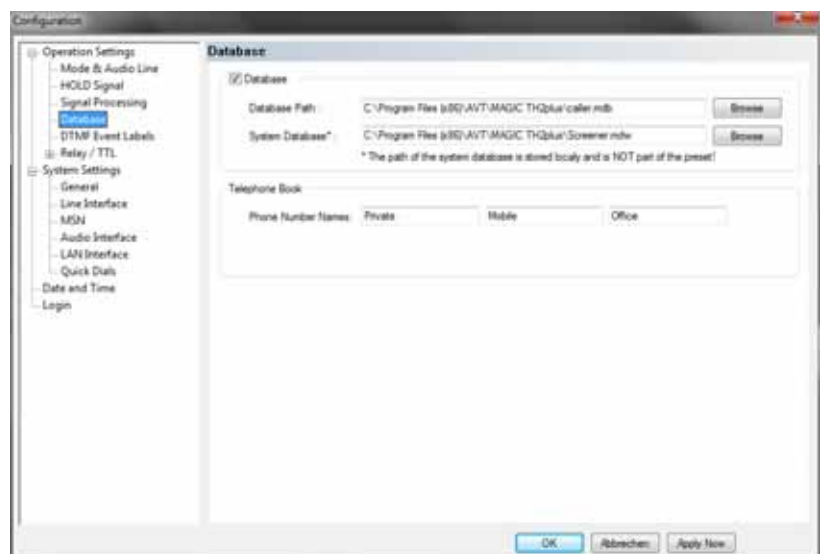

- To enable the use of a database, please select **Database** and enter the correct path under **Database Path**. Via **Browse** you can search for the correct folder.
- The path of the **System Database** is usually entered automatically when the software is installed. By default, the file **Screener.mdw** is saved in the installation directory. If you do not have write permission for the installation directory, you must change the path of the **System Database** to a directory for which you have write permission. Otherwise, you will not be able to use the database.

Telephone Book

Under **Phone Number Names** you can define which number types are to be available in the telephone book. You can enter maximum three names.

5.7.2.1.5 DTMF Event Labels

NOTE

This menu item will only be displayed if the fee-based **DTMF Tone Generation & Analyser Plug-In** software option (see CHAPTER 6, Page 93) is enabled in your system.

DTMF Event Labels

Under **DTMF Event Labels** you can define the so-called Event Labels for the **DTMF Event Mode**.

FIG. 35 DTMF EVENT LABELS

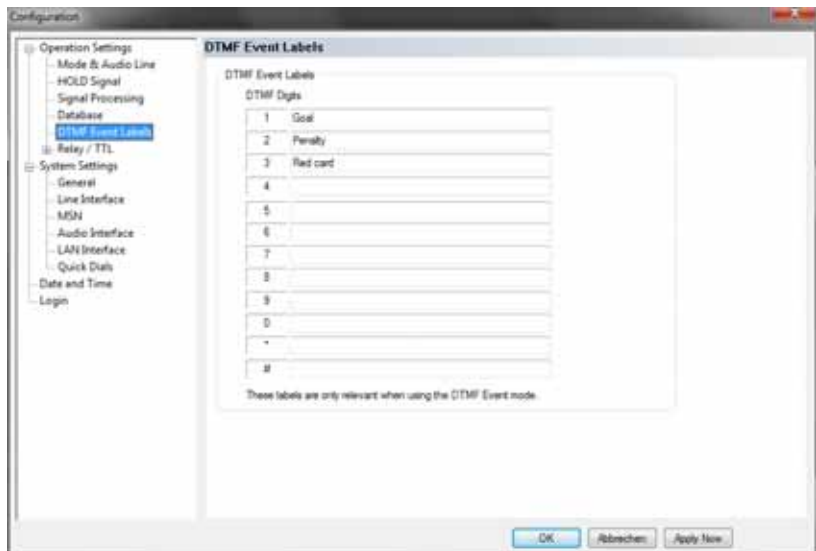

The **DTMF Event Mode** is described in detail in CHAPTER 6 (see Page 93).

5.7.2.1.6 Relay / TTL

The **MAGIC TH2plus** system incorporates four **GPIO** Pins (TTL) which can be programmed separately as input or output. Additionally, two **Relays** are available.

The operating mode of a TTL Pin - **Input** or **Output** - is selected via the option **Direction**.

The following specification accounts for all three configuration windows **TTL1**, **TTL2**, **TTL3** and **TTL4**.

TTL Pin as input

FIG. 36 TTL PIN AS INPUT

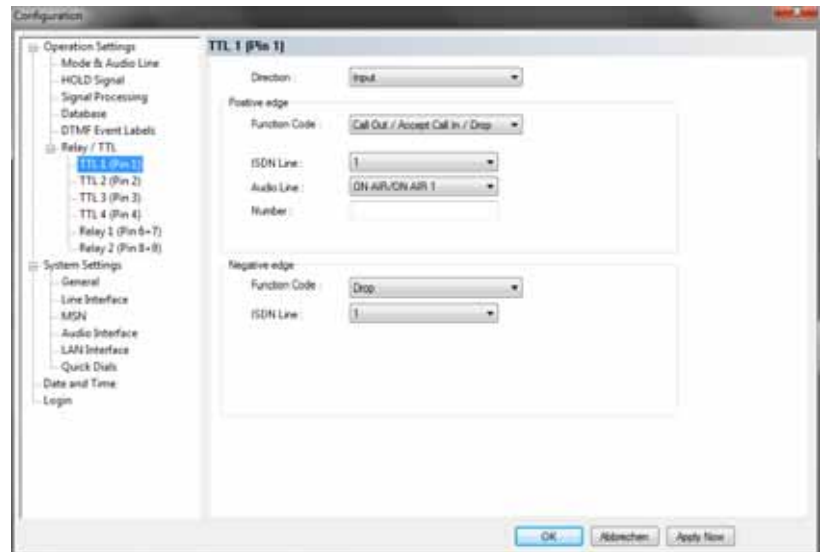

If you use a TTL Pin as **Input**, you can program two different functions separately when edges change:

- **Positive edge:** The event is activated when the voltage on the TTL Pin changes from 0V to +3.3V.
- **Negative edge:** The event is activated when the voltage on the TTL Pin changes from +3.3V to 0V.

The following functions can be configured (**Function Code**):

- - : No function, the Pin is not used.
- **Call Out/Accept Call In/Drop:** Via this function you can establish a connection to a certain **Phone Number**, accept an incoming call or drop a call. Under **POTS Line/ ISDN Line** you select the line (**1** or **2**) on which the connection is established. Under **Audio Line** you select the Audio line which is activated when the call is accepted.
- **Call Out (Level Trig.):** Same function as above, however, except that here the level is analysed and not the edge (level triggered).
- **Drop:** If you activate this function, a connection on the selected line (**1** or **2**) can be dropped.

- **Set Audio Line:** This function allows you to switch a caller to a pre-defined **Audio Line**. Under **POTS/ISDN Line** you must indicated which caller line you want to use (**1** or **2**).
- **Lock Audio Line (Level Trig.):** With this function you can lock an **Audio Line**. Under **POTS/ISDN Line** you must indicated which caller line (**1** or **2**) is locked for the selected Audio line. This function is level triggered.
- **Load Preset:** Via this function it is possible to load a preset which you have to select under **Preset**.
- **Set Information Base Entry:** Special function for projects.
- **String Command:** Special function for projects.
- **Suppress Ring Tone (Level Trig.):** This function allows you to suppress the ring tone for an incoming call.
- **Connect via DTMF/Accept Call In: ...**

Example 1:

You want to accept a call on line 1 with TTL 1. The caller is to be switched directly in the **ON AIR** mode. After the conversation has been finished the connection is to be cleared with TTL 1.

Programming:

Positive egde:

Function Code: Call Out/Accept Call In/Drop
 Audio Line: ON AIR
 Line: Line 1
 Phone Number: -

Negative egde:

Function Code: Drop
 Line: Line 1

FIG. 37 SEQUENCE OF EVENTS FOR THE EXAMPLE 1

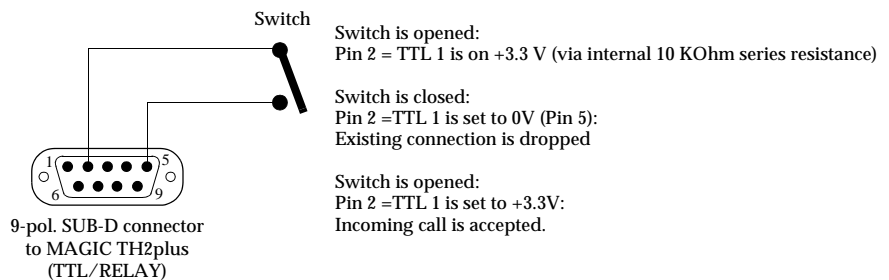

TTL Pin as Output

ATTENTION



Please pay attention to the maximum switch current of 10 mA respectively the maximum switch voltage of 3.3V per TTL output.

FIG. 38 TTL PIN AS OUTPUT

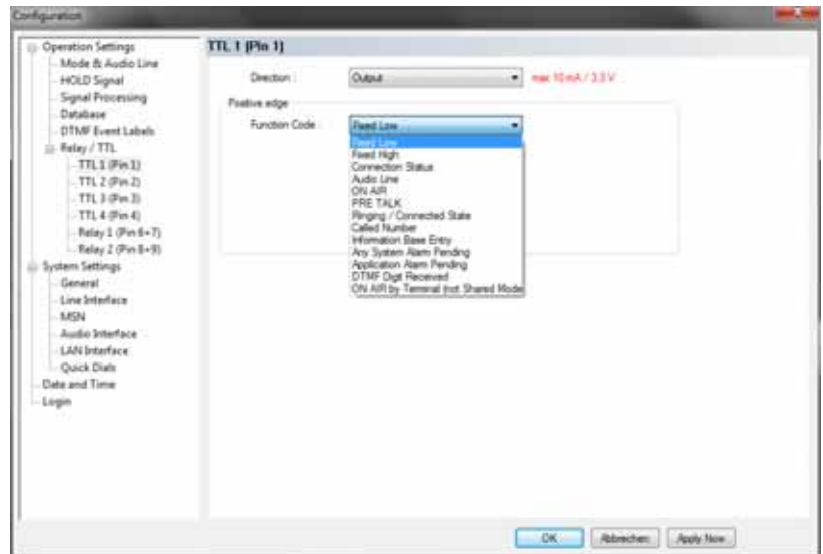

If a TTL Pin is configured as **Output**, the event is signalled as change of voltage on the TTL Pin from 0V to +3.3V.

Under **Positive edge** you can select one of the following **Function Codes**:

- **Fixed Low**: The TTL Pin is set to 0V permanently.
- **Fixed High**: The TTL Pin is set to +3.3V permanently.
- **Connection Status**: Via this function you can signal the connection status of a line. Select the connection status under **Connection Status**. The following options are possible:
 - **Disconnect**
 - **Calling**
 - **Incoming call**
 - **Connect**

Under **POTS/ISDN Line** you select if you want to signal the status of Line 1, Line 2 or both lines (**Any**). If you select **Any**, the signal is set on the TTL Pin as soon as one of the lines has the pre-defined status.

- **Audio Line**: With this function you can signal when a caller is switched to a certain Audio line. Please select under **Audio Line** the desired Audio line. Under **POTS/ISDN Line** you select if you want to signal the status of Line 1, Line 2 or both lines (**Any**). If you select **Any**, the signal is set on the TTL Pin as soon as one of the lines has been set to the pre-defined Audio line.

- **ON AIR:** If you select this function, it is signalled when a caller is switched to ON AIR. Under **POTS/ISDN Line** you select if you want to signal the ON AIR status of Line **1**, Line **2** or both lines (**Any**). If you select **Any**, the signal is set on the TTL Pin as soon as one of the lines is switched to ON AIR.
- **PRETALK:** If you select this function, it is signalled when a caller is switched to Pretalk. Under **POTS/ISDN Line** you select if you want to signal the Pretalk status of Line **1**, Line **2** or both lines (**Any**). If you select **Any**, the signal is set on the TTL Pin as soon as one of the lines is switched to Pretalk.
- **Ringin/Connected State:** Toggeling of voltage when a call is coming in (e.g. for flashing light). When the connection is established, the TTL Pin is set.
- **Called Number:**
- **Information Base Entry:** Special function for projects.
- **Any System Alarm Pending:** This function signals any system alarm.
- **Application Alarm Pending:** If you enable this function, you can select under **Alarm** which Application Alarm you want to signal.
- **DTMF Digit Received:**
- **ON AIR by Terminal (not Shared Mode):**

If you select the option **Inverted**, which is displayed next to the function code, the inverted signal is transmitted.

Relay

ATTENTION



Please pay attention to the maximum switch current of 200 mA respectively the maximum switch voltage of 48V per relay output.

The following description applies for both configuration windows **Relay 1** and **Relay 2**.

FIG. 39 RELAY

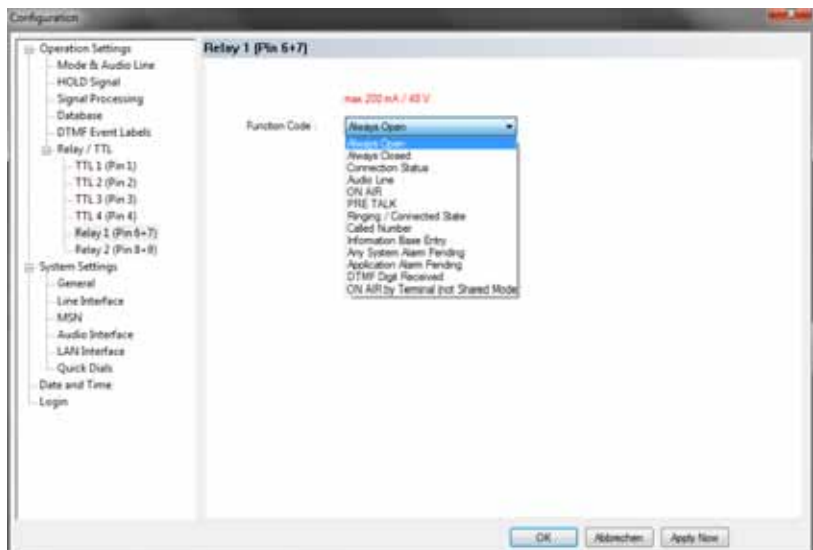

The functions for programming the relays are identical with the function codes for the TTL output. The following **Function Codes** are available:

- **Always open:** The relay contacts are always open.
- **Always closed:** The relay contacts are always closed.

All further function codes are explained under TTL Pin as Output on Page 57.

5.7.2.2 System Settings

5.7.2.2.1 General

FIG. 40 GENERAL

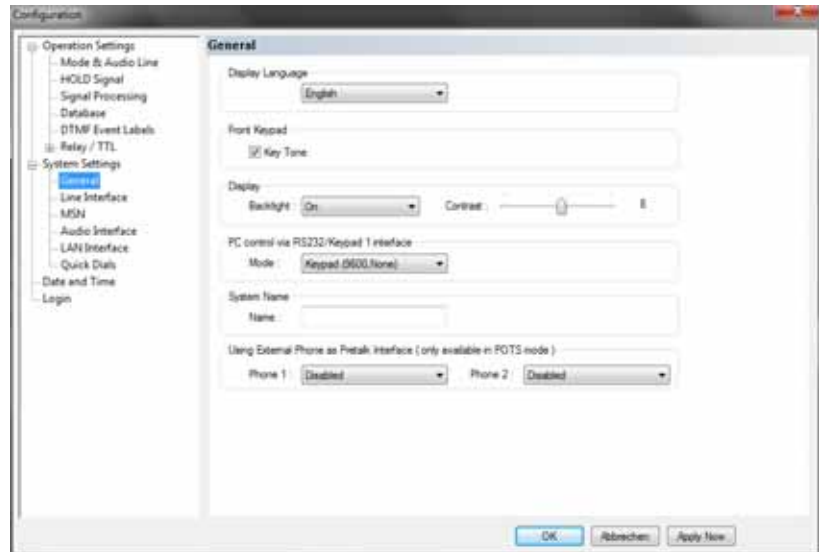
**Display Language**

- Currently **English** and **German** are available as display languages.

Front Keypad

- To activate the key tone, check the **Enabled** box.

Display

- The **Display** has a backlight. Under the setting **Backlight** you can switch it **ON** permanently. If you select the option **Auto** the backlight is turned off automatically **60** seconds after the last keystroke. The backlight is activated again by pressing any key (e.g. **OK**).

NOTE

Please note that if the keypad lock is activated, the backlight is only switched on after pressing the key sequence **Menu ***.

- Via the slide control **Contrast** you can adjust the contrast for the display within the range **0 ... 15**. The default setting is **0**.

PC control via RS232/Keypad 1

- If you want to operate the system with the PC via RS232 or you want to use a **MAGIC TH2plus Keypad**, you must set the data rate in accordance with the interface. There are five baud rates available: **Keypad (9600 Baud, None)**, **PC (19200 Baud, None)**, **PC (38400 Baud, None)**, **PC (57600, None)** and **PC (115200, None)**.

NOTE

The **MAGIC TH2plus Keypad** supports only the baud rate 9600 Baud. Therefore, please select the option **Keypad (9600 Baud, None)** if you use a keypad.

If you connect a PC via the RS232 interface, the selected baud rate must correspond with the baud rate of the COM interface ((see CHAPTER 5.7.1). Please note that the LAN interface is deactivated if you use the RS232 interface for PC control.

System Name

- Under **Name** you can assign a name to your system.

Using External Phone as Pretalk Interface (only available in POTS mode)

- If you want to use an external POTS Telephone for Pretalk, please select **Enabled** under **Phone 1** or/and **Phone 2**. If you use a handset or a headset, please select the option **Disabled**.

NOTE

Please note that an external phone can only be used when **MAGIC TH2plus** is operated in POTS line mode.

5.7.2.2.2

Line Interface

Via the option **Line Interface** the settings for the operating mode (ISDN, POTS and optional VoIP) can be configured.

FIG. 41 LINE INTERFACE - ISDN

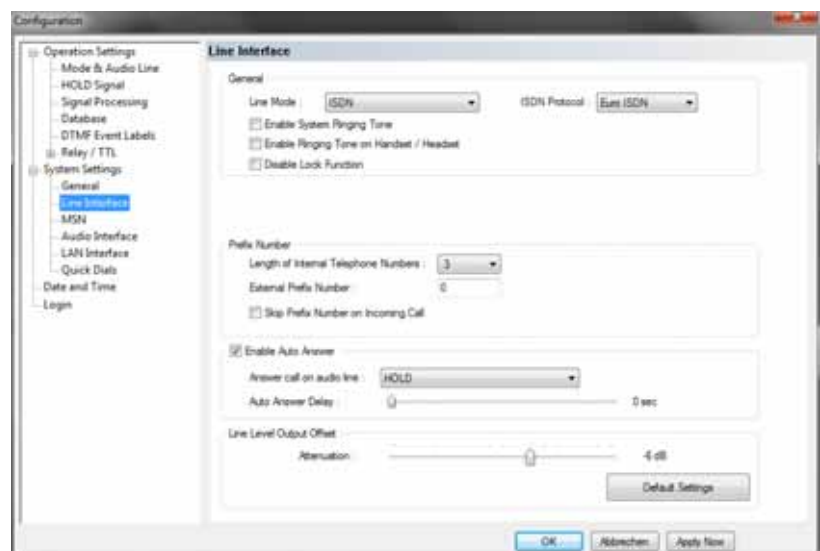
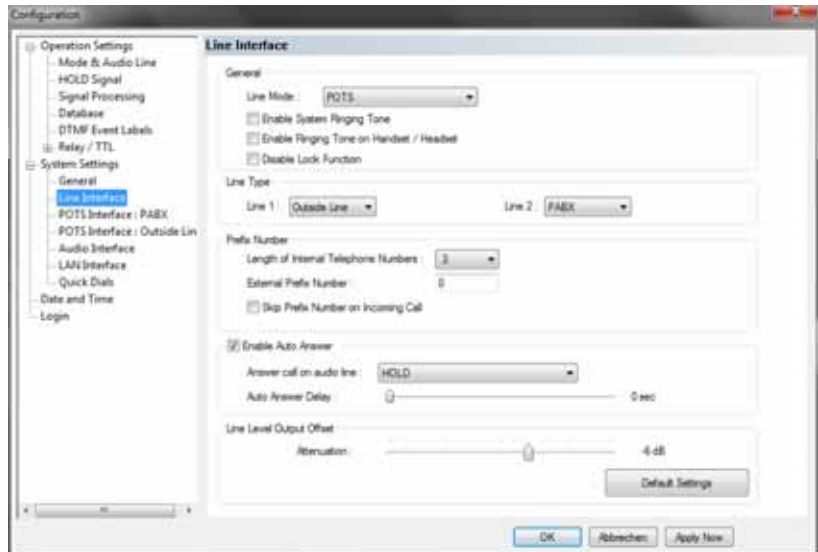

FIG. 42 LINE INTERFACE - POTS



General

- Via the option **Line Mode** you can select the line interface. The following configurations are possible:
 - **ISDN**: The system is connected to the ISDN network.
 - **POTS**: The system is connected to analogue telephone lines.
 - **VoIP**: The system is connected to the IP network.

NOTE

The line mode VoIP can only be selected if the fee-based **Extension for Voice over IP** option (ID: 430399) is enabled in your system.

ISDN

- If the **ISDN mode** is selected, you can configure which **ISDN Protocol** you want to use. The following options are available:
 - **Euro ISDN**
 - **USA ISDN (NI-1)**
 - **Japanese ISDN**
- It is possible to activate a ring tone for incoming calls via the function **Enable System Ringing Tone**.
- If you select **Enable Ringing Tone on Handset/Headset** incoming calls can be signalled via the Pretalk Audio line if a telephone handset or headset is connected.
- If you activate the function **Disable Lock Function**, caller lines cannot be locked for incoming calls. The **LOCK ALL** button will not be displayed.

POTS

Line Type

- If you operate the **MAGIC TH2plus** with POTS telephone lines, you can select under **Line 1** and **Line 2** if the system is connected to a **PABX** or to an **Outside Line**.

Depending on your selection the menu items **POTS Interface: PABX** and/or **POTS interface: Outside Line** are displayed on the left side of the configuration window. In this way you can configure the settings for the POTS interfaces individually. This feature is especially helpful if you operate one POTS interface via a PABX and the other POTS interface is connected to an outside line.

Prefix number

NOTE

The following configurations are only necessary if the system is operated with a private branch exchange.

- Under **Length of internal telephone numbers** the length of your internal telephone numbers is set. Subsequently, the prefix number is automatically dialled first if the length of the telephone number exceeds the length specified in this setting.
If you do not want to use this function or if you operate the system with an outside line, enter **0**.

Examples:

Length of internal telephone numbers: 3
Entered telephone number: 130
Dialling: 130

Length of internal telephone numbers: 3
Entered telephone number: 5271130
Dialling: **0** 5271130

- Under **External prefix number** please enter the prefix number that you need to get an external line. In most cases it is **0**.

ATTENTION



You need to enter the prefix number at any rate if you work with a private branch exchange because otherwise the system does not wait for the free-line signal. Without dialling the prefix number at a private branch extension the telephone number is transmitted too fast and no connection can be established.

- Some private branch exchanges transmit telephone numbers with prefix number to the system. If you enable the function **Skip prefix number on incoming call**, you can save a displayed number in the phone book without prefix number since the prefix number of the displayed number is deleted automatically.

Auto Answer

- You can enable the system to accept incoming calls automatically. For this function please activate the option **Enable Auto Answer**.
- Under **Answer call on audio line** you can select the Audio line to which the caller will be switched after he has been accepted by the system.
- To delay the automatic answer of an incoming call, the option Auto Answer Delay is available. You can adjust the setting within the range of **0 sec** and **31 sec**.

Line Level Output Offset

- Under **Attenuation** you can adjust the **Line Level Output Offset** within the range of **- 16 dB ...0 dB**. The default setting is **-6 dB**.

ISDN

5.7.2.2.3

MSN

NOTE

An MSN can only be set if the ISDN operating mode is selected (see CHAPTER 5.7.2.2.2, Page 61). If you have not selected **ISDN** as your operating mode, this menu item is not displayed.

FIG. 43 MSN

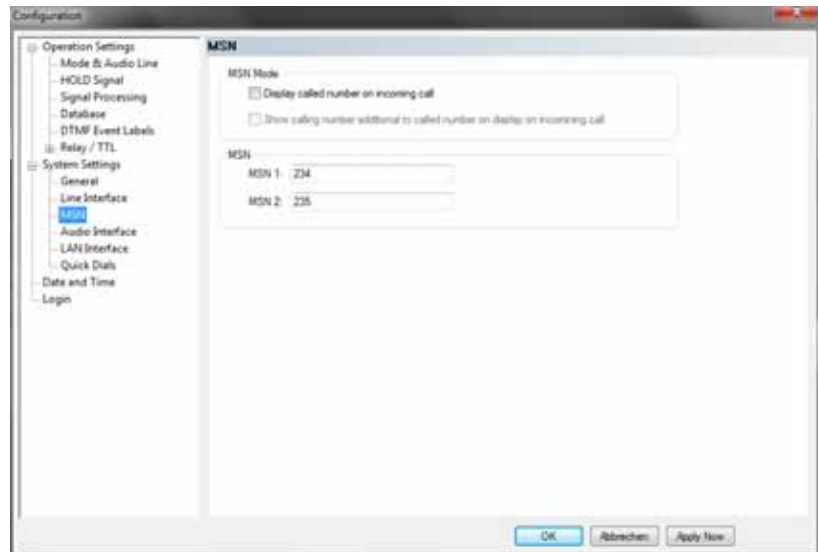

Normally, an MSN entry is not necessarily required. However, if you operate further units on your ISDN interface, you can allocate a certain number to a certain unit by an MSN entry. When you order an ISDN user port in Germany, you usually receive three MSNs, which you can use for your connected units.

NOTE

Some PABX require the entry of MSNs.

MSN Mode

- If you activate the function **Display called number on incoming call**, the MSN dialed by the caller is displayed.

NOTE

This function will not work with PABX that require the entry of MSNs.

- If the option **Show calling number additional to called number on display on incoming call** is enabled, the telephone number of the caller is displayed in addition to the MSN.

Called Number Labels

- Under **Called Number Labels** you can define labels for up to four MSNs. These labels will be displayed if the caller dialed the MSN entered here.

FIG. 44 CALLED NUMBER LABELS

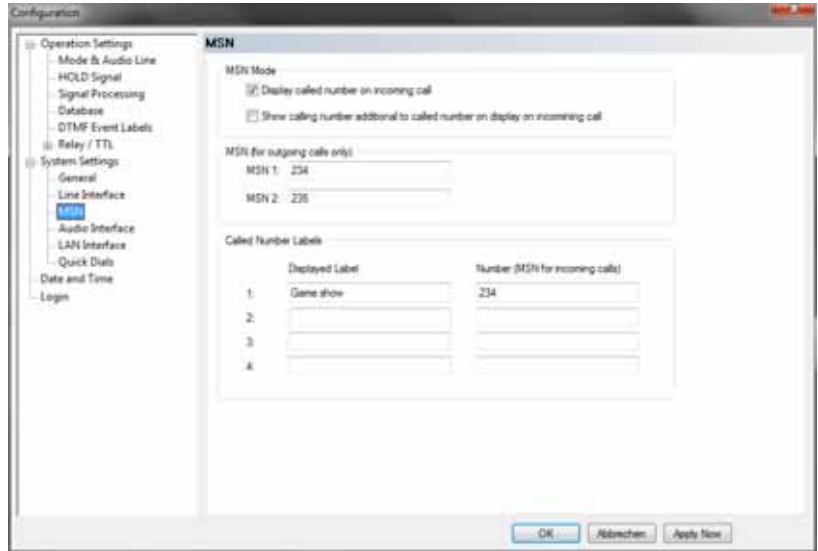

POTS

5.7.2.2.4

POTS Interface: PABX

If you operate the **MAGIC TH2plus** in the POTS mode and one of your POTS interfaces is connected to a PABX, you can adjust the settings for the POTS interface here.

NOTE

You must select **PABX** as **Line Type** under **Line Interface** to get this menu item displayed (see Page 62).

FIG. 45 POTS INTERFACE: PABX

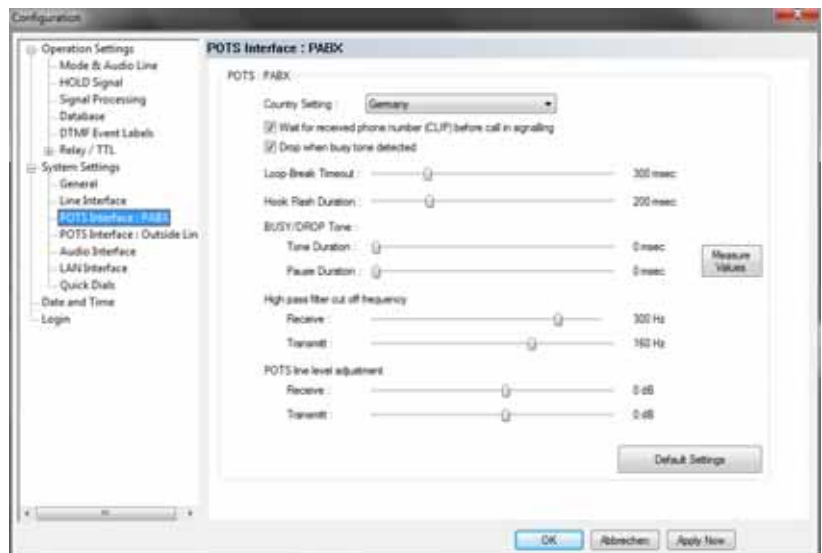

POTS: PABX

Under **Country Setting** you can select which country-specific POTS interface you use..

NOTE

This setting is important for the Audio quality. The impedance of the POTS interface may vary from country to country and the Echo Canceller of the system can only work correctly if the right Country Setting is selected.

If your PABX has been manufactured in a different country, you should also try the origin country as Country Setting.

TIP

If you want to connect the **TCU-100/121 GSM Adapter** (ID: 490135) to one of the POTS interfaces of **MAGIC TH2plus**, please select **GSM Adapter: TCU-100E** as **Country Setting**.

- The function **Wait for received phone number (CLIP) before call in signalling** allows you to decide whether you want to see an incoming call immediately displayed or if you want to wait until the telephone number of the caller is transmitted. The signalling of the telephone number will take 2 - 3 ringing tones.
- If you want to drop the connection when the system detects a busy tone on the called end, you can select **Drop when busy tone detected**.
- Under **Loop-Break Timeout** you must select the time the system needs to eliminate loop-break disturbances to answer a call. Usually, values from 300 msec to 500 msec should be sufficient. If you have problems with these values, you should select a higher one.
- The **Hook Flash Duration** depends on your PABX or outside line and is required for call forwarding.
- The Busy/Drop Tone may vary from country to country. Therefore, you can measure the values with the function **Measure Values** under **BUSY/DROP Tone**. In this way you make sure that the system recognises when a call is dropped or when the line is busy.
To measure the Busy/Drop tone you just need to e.g. call a busy line **on caller line 1** and press the button **Measure Values**.
- Under **High pass filter cut off frequency** you can select different filter values for **Receive** and **Transmit** direction to eliminate disturbances in the telephone signal. All signal parts below the selected frequency are eliminated. The recommended setting is **300 Hz** for both directions.
- Under **POTS line level adjustment** you can adjust the level for the telephone signal separately for the Receive and Transmit direction.

POTS

5.7.2.2.5

POTS Interface: Outside Line

If you operate the *MAGIC TH2plus* in the POTS mode and one of your POTS interfaces is connected to an outside line, you can adjust the settings for the POTS interface here.

NOTE

You must select **PABX** as **Line Type** under **Outside Line** to get this menu item displayed (see Page 62).

FIG. 46 POTS INTERFACE: OUTSIDE LINE

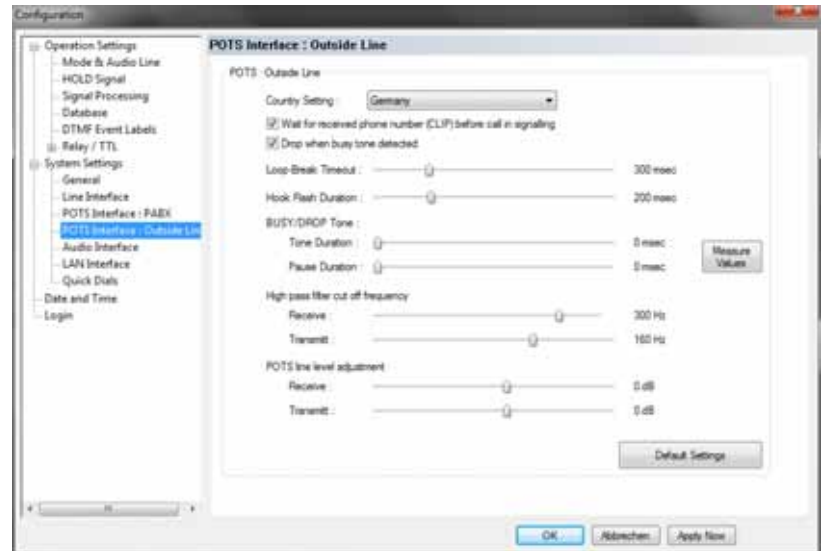

For configuration see **POTS Interface: PABX** (see CHAPTER 5.7.2.2.4, Page 65).

If you operate **MAGIC TH2plus** in the VoIP mode (only with the fee-based option „Extension for VoIP“, Id. 430399, available), you need to configure the settings for the IP connection and the SIP Server under this menu item.

FIG. 47 VOIP (LAN/SIP)

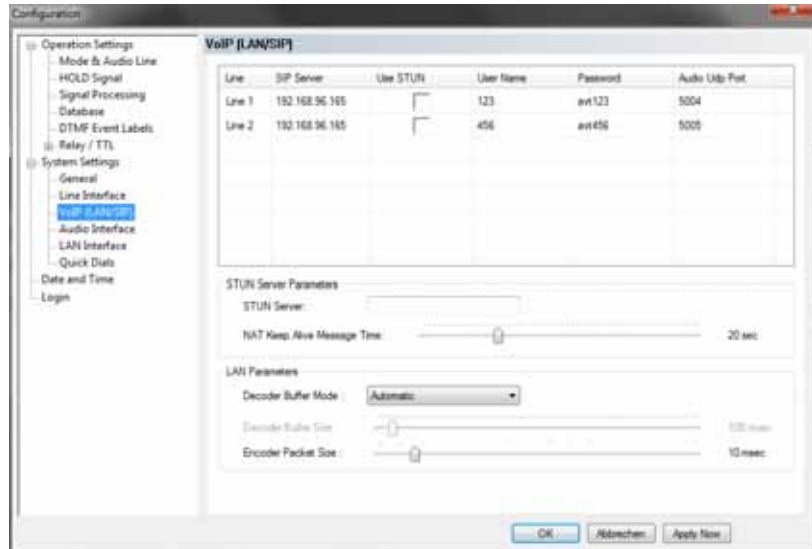

In the upper part of the window the settings for the SIP Server can be configured. You need to enter the IP Address of the SIP Server to which you are connected for **Line 1** and **Line 2** under **SIP Server**.

If you work with a STUN¹ Server, please select the option **Use STUN**.

Under **User Name** and **Password** you can enter the credential settings of your system for the registration at the SIP Server

Under **Audio UDP Port** you need to enter the UDP Port which you use for your Audio transmission.

STUN Server Parameters

- If you use a STUN Server, please enter the IP Address here.

LAN Parameters

- **Decoder Buffer Mode:** The Audio transmission over IP networks via UDP² requires a buffer in the decoder due to the different transmission times of the individual IP packets within the network (Jitter). By default the buffer mode should be set to **Automatic**. To be on the safe side, the automatic mode selects a larger buffer than it might be required. If you know the parameters of your network provider, you can select a **Fixed** buffer. In this way, the total delay of an Audio transmission can be optimised.

¹ STUN (Simple Traversal of UDP through NATs (Network Address Translation)) is a protocol for assisting devices behind a NAT firewall or router with their packet routing.

² UDP = User Data Protocol

- **Decoder Buffer Size:** If the **Decoder Buffer Mode** is set to **Fixed**, you can select the buffer size within the range of **20 ... 2000 msec**.

ATTENTION If you experience packet loss, please try to set a larger buffer.



-
- **Encoder Packet Size:** To optimise the total delay, the size of the encoder packets can be adjusted. The IP Overhead will be minimised when a larger packet size is selected. However, in this case the total delay will be increased and if a larger packet is lost, the audible disturbance is much higher. The packet size can be adjusted with the range of **4... 50 msec**.

5.7.2.2.7 Audio Interface

MAGIC TH2plus supports analogue as well as digital AES/EBU Audio interfaces. If the digital Audio inputs are used, a Sample Rate Converter is available so that external adjustments are not required if there are different digital sources and drains.

FIG. 48 AUDIO INTERFACE

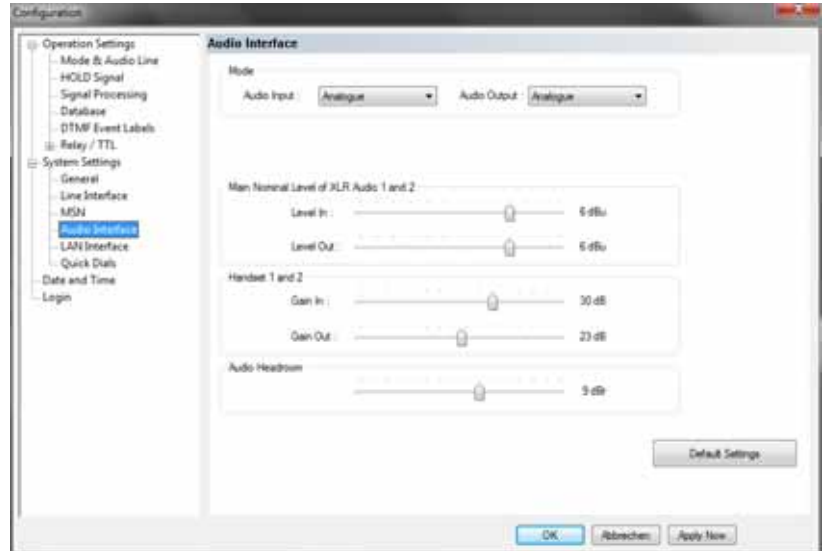

Mode

- The operating mode *analogue* or *digital* can be set separately for the **Audio Input** and the **Audio Output**.

POTS, VoIP

AES/EBU Interface

- If the *digital* output is selected, the configuration for the **AES/EBU Interface** is displayed. Under **Clock Source of digital output** you can select the following options:
 - Internal:** The AES/EBU output clock is derived from the internal system clock.
 - External:** The AES/EBU output clock is derived by the external clock connected via the interface **Audio 2/CLK IN**. The clock rate of the connected clock must be 48-kHz.
 - Recovered:** The AES/EBU output clock is derived from the digital input signal of the interface **Audio 1/AES IN**. This configuration is usually to be selected if you use the digital input of the system. In this way a synchronous functioning of the transmission chain is ensured

NOTE

In the ISDN Mode, the clock of the AES/EBU output is always derived from the ISDN clock. Therefore, if the ISDN Mode is selected, this settings will not be displayed.

The AES/EBU input always works with recovered clock, therefore only a configuration of the output is required.

For clock synchronisation to other systems you can use the Audio output **Audio 2/CLK OUT**. The clock rate of the output clock is 48-kHz.

Main Nominal Level of XLR Audio 1 and 2

- If you use the **analogue** input or the output, the corresponding slide control for adjusting the nominal Audio level of the **ON AIR** interface is displayed. The nominal level can be adjusted separately for the input (**Level In**) and the output (**Level Out**) in the range of **-3 ... +9 dBu** in 1 dB steps.

Handset 1 and 2

- If you use a handset for Pretalk, you can adjust the settings for the level under **Handset 1 and 2**. You can set the Audio level separately for the input (**Gain In**) and the output (**Gain Out**) within the range of **0... +45 dBu** in 1 dB steps.

Audio Headroom

Here you can adjust the Audio headroom within the range of **0 ... +15 dB**.

5.7.2.2.8 LAN Interface

Under **LAN Interface** the configuration of the LAN Interface and the entry of the

FIG. 49 LAN INTERFACE

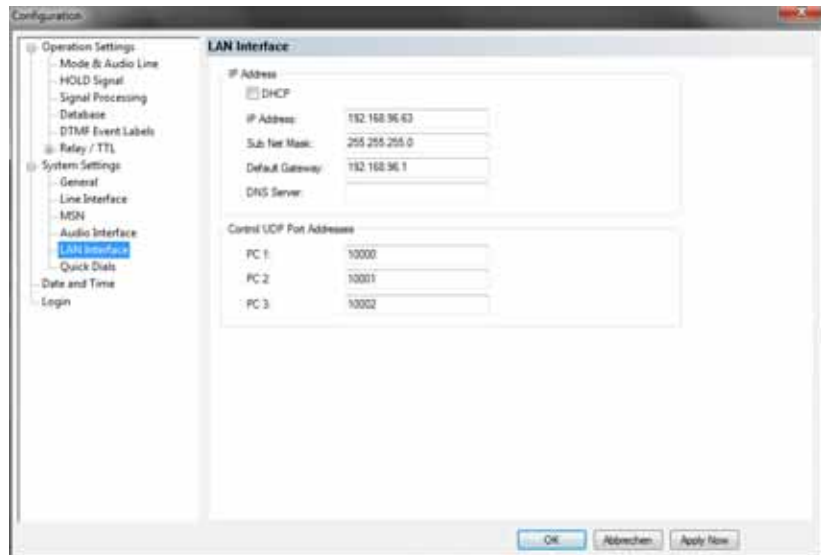

IP Address

- To automatically get the correct LAN settings for your system, you can activate the option **DHCP** (Dynamic Host Configuration Protocol), if a DHCP Server is available.

Alternatively, you can also adjust the settings manually.

- Under **IP Address** you need to enter the IP address of your system. When entering it manually, please make sure that the IP address is not already used by another system within your network¹.

TIP

The currently allocated IP address of the system can be displayed by pressing the telephone button  on the front keypad of the system if currently no Audio connection is established.

The standard **IP Address** of the system is **192.168.96.102**.

- Please enter under **Subnet Mask** in which subnet you are located (by default 255.255.255.0).

NOTE

To connect the system with your PC, **MAGIC TH2plus** and your PC have to be in the same **subnet**^a.

- a In this way you can find out your own subnet: Under *Windows XP* click on Start → *Execute...* Under *Windows 7* click on Start → *Search...* . Enter *cmd* in the command line/search field. An entry window is displayed in which you must enter *ipconfig*. Your IP address is displayed (e.g. 192.168.12.35). Your subnet is accordingly 192.168.12.xxx.

¹ To check if the IP address is already used in the network, follow the instructions: Under *Windows XP* click on Start → *Execute...* Under *Windows 7* click on Start → *Search...* . Enter *cmd* in the command line/search field. An entry window is displayed in which you must enter *ping xxx.xxx.xxx.xxx*. Whereas xxx stands for the IP address you want to check.

Control UDP Port Addresses

- Under **Control UDP Port Addresses** you must enter the Port Addresses of the PCs that are connected to the **MAGIC TH2plus**. You can have access to the system simultaneously via maximum **three** PCs.

NOTE

You can only use more than one PC, if you have more than one **MAGIC TH2plus PC Software Licence** (fee-based, ID: 430396).

5.7.2.3

Quick Dials

Up to 10 Quick Dial keys **0...9** can be programmed in the system.

FIG. 50 QUICK DIALS

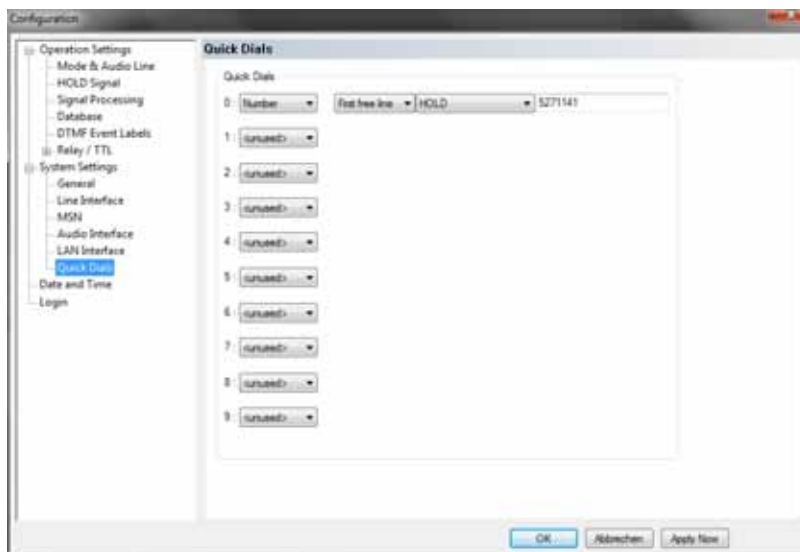

- You can program either a **Number** or a **Preset** as Quick Dial.
- If you want to program a **Number**, you must enter the telephone number and additionally select if you want to establish the connection on **Line 1**, **Line 2** or on the **First free line**. Furthermore, you must select to which Audio line the called person is to be switched when he answers the call.
- If you want to program a **Preset**, you just need to select the desired Preset.

5.7.2.4 Date and Time

- Under **Date and Time** you can program the system date and time.
- Via the button **Transmit PC Time** you can synchronise the system time with the PC time.
- The button **Transmit User Defined Time** allows you to set a different time. This function is helpful, if you want to use the system e.g in a different time zone.

FIG. 51 DATE AND TIME.

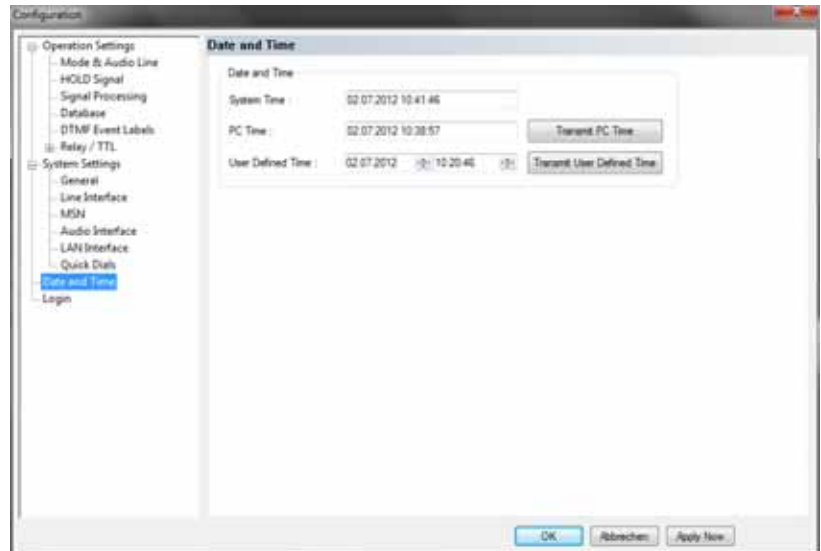

ATTENTION During a power breakdown the integrated system clock is buffered by an internal battery. The life time of a battery is typical ca. 7 years. The replacement should only be done by the AVT Service.



5.7.2.5 Login

To protect the system from reconfigurations, two password levels with different user rights are available.

ATTENTION



The entered password is saved in the system. If you have forgotten your password, only the AVT Service can re-activate the system.

- Under **USER** you assign the user **Password**. For safety reasons you must confirm the password under **Confirm Password**.
- Under **ADMINISTRATOR** you assign the Administrator **Password**. For safety reasons you must confirm the password under **Confirm Password**.

NOTE

There is no differentiation between upper and lower case for the password entry.

FIG. 52 LOGIN

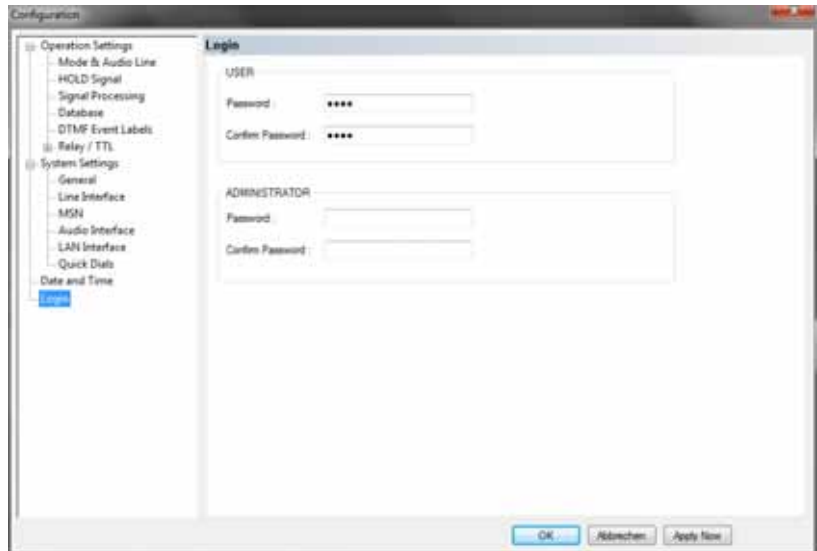

When you have assigned a password, the window for the password entry is automatically displayed when you click on a menu with password protection. Please enter the User Password or the Administrator Password.

FIG. 53 PASSWORD LOGIN

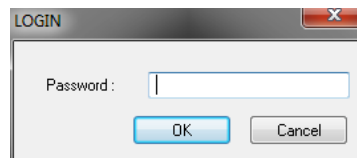

The authorisation levels are defined as follows:

- (1) Only **Administrator Password** is configured: The password must be entered for configuration changes. Immediately available menus:

- **Configuration** → **Presets** → „**Configuration Name**“
 - **Extras** → **System Monitor**
- (2) Only **User Password** is configured: The password must always be entered. Afterwards all menus are available. Immediately available menu:
- **Extras** → **System Monitor**
- (3) **User Password** and **Administrator Password** are configured: The password must always be entered.
- **User Password** is entered:
Under **Configuration** → **Configuration** → **Login** the **USER** password can now be changed.
Via **Configuration** → **Presets** the desired configuration can be loaded.
Immediately available menu: **Extras** → **System Monitor**
 - **Administrator Password** is entered: All menus are available.

NOTE

Please pay attention to the configuration options of the system if a password is assigned (see CHAPTER A1).

5.7.3 Submenu Presets

Via **Presets** you can edit, delete or load already existing Presets or create new ones.

5.7.3.1 Manage Presets

Your created **Presets** can be managed via the menu **Configuration** → **Presets** → **Manage Presets**.

FIG. 54 MANAGE PRESETS

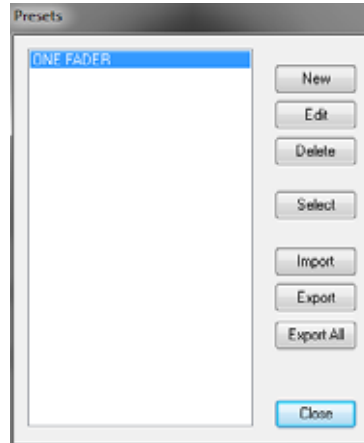

All already existing Presets are displayed in the list.

- With the use of the **New** button you create a new Preset. The current configuration of the system is not changed by this function. First, select an meaningful name. The length of the name must not surpass 8 characters. Special characters are **not** allowed. Please mind that you use unique names.

FIG. 55 NEW CONFIGURATION

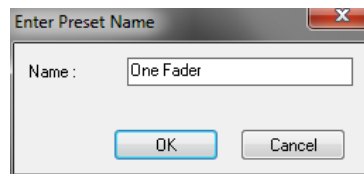

Subsequently, the configuration dialogue is opened to edit the **Preset**. The current configuration is always displayed as basis of a **Preset** which you can adjust according to your wishes. The following configurations can be saved as Preset:

- **Mode & Audio Line** (see Page 47)
- **HOLD Signal** (see Page 51)
- **Signal Processing** (see Page 52)
- **Database** (see Page 53)
- **Relay / TTL** (see Page 55)

FIG. 56 EDIT PRESET

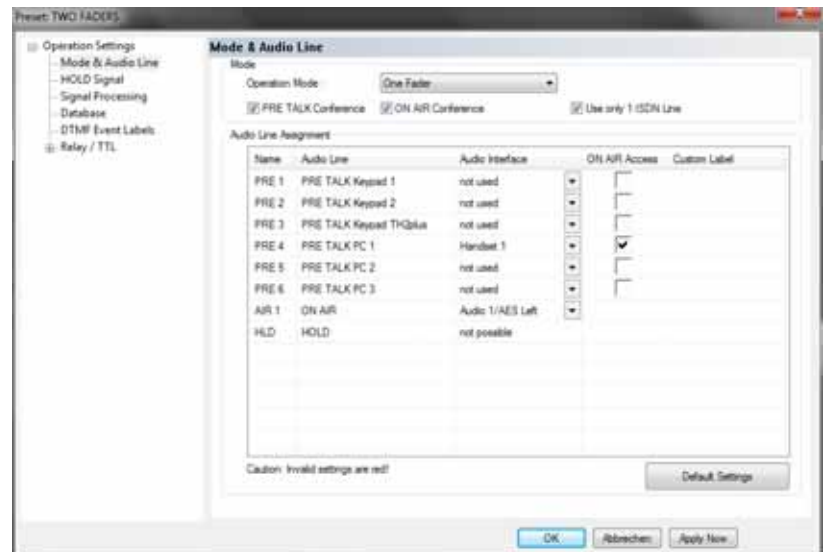

- By using the button **Edit** the currently selected Preset can be edited. The current configuration of the system is not changed with this function.
- Via the button **Delete** the Preset selected from the list is deleted. For safety reasons you have to confirm your selection.

FIG. 57 CONFIRMATION TO DELETE A PRESET

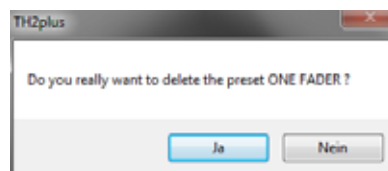

- To activate a Preset selected from the list, press the **Select** button. For safety reasons you have to confirm your selection.

FIG. 58 CONFIRMATION TO LOAD A PRESET

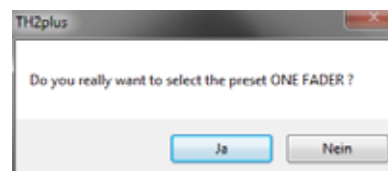

- Via the button **Import** a Preset can be imported from a data carrier (disk, USB stick etc.). The file extension of the Preset file is always **.T2P**. A click on the button opens the file browser in which the desired file can be selected.

- Likewise, it is possible to export Presets to a data carrier. The button **Export** saves the Preset selected from the list as **.T2P** file. By clicking on the button the file browser is opened and you can choose the location where the file is saved.
- With **Export All** all Presets displayed in the list are saved in a directory of your choice. A separate data file with the file extension **.T2P** is generated for each Preset.

TIP

If you need to configure several systems in the same way, set up one system first and export all Presets to a disk. To configure all further systems easily, import the Presets from the disk.

5.7.3.2 Activation of a Preset

All Presets are displayed under **Configuration** → **Presets** → „**Preset Name**“ and can be activated with a click.

FIG. 59 LOAD PRESET

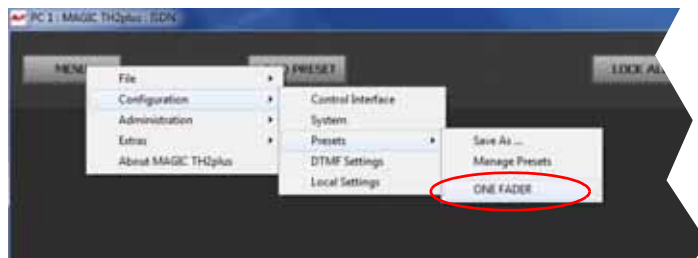

For safety reasons a confirmation is required.

FIG. 60 CONFIRMATION LOAD PRESET

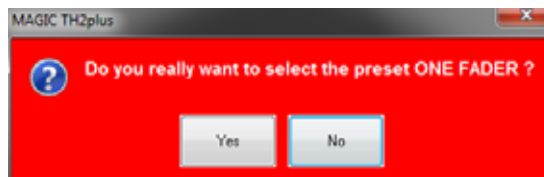

5.7.4 Submenu DTMF Settings (Option)

The menu **DTMF Settings** is only displayed if the fee-based option **DTMF Tone Generation & Analyzer Plug-In (ID: 430200)** is available. Further details you will find in CHAPTER 6, Page 93.

FIG. 61 SUBMENU DTMF SETTINGS

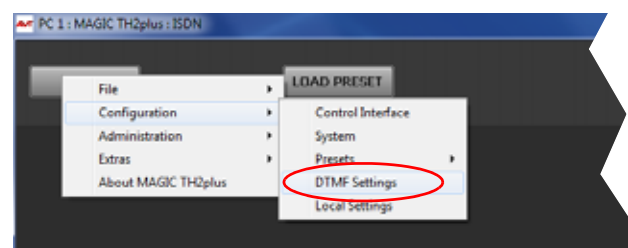

5.7.5 Submenu Local Settings

Under **Local Settings** you can decide if you want to store the settings of your configuration only for the current user or globally for all users. Additionally, you can change the layout of the user interface.

FIG. 62 LOCAL SETTINGS - WINDOW PARAMETERS

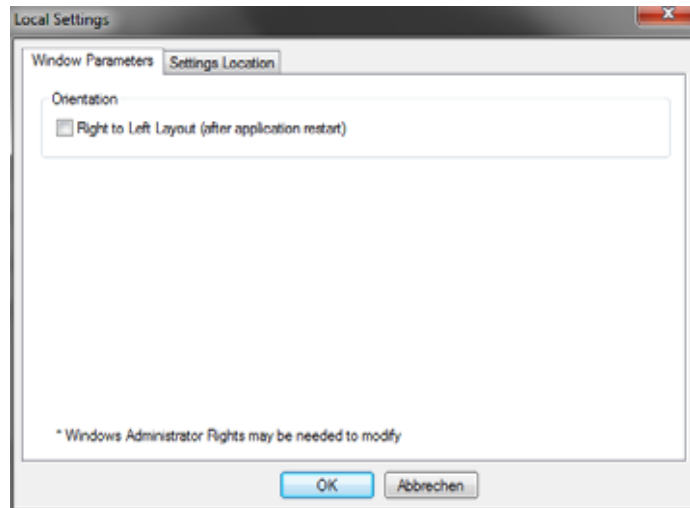

Window Parameters

- Under **Orientation** you can select the option **Right to Left Layout (after application restart)** to display the layout of the user interface from right to left instead of left to right. This setting will only be applied after you closed and restarted the **MAGIC TH2plus Software**.

FIG. 63 PC SOFTWARE - RIGHT TO LEFT DISPLAY



FIG. 64 LOCAL SETTINGS - SETTINGS LOCATION

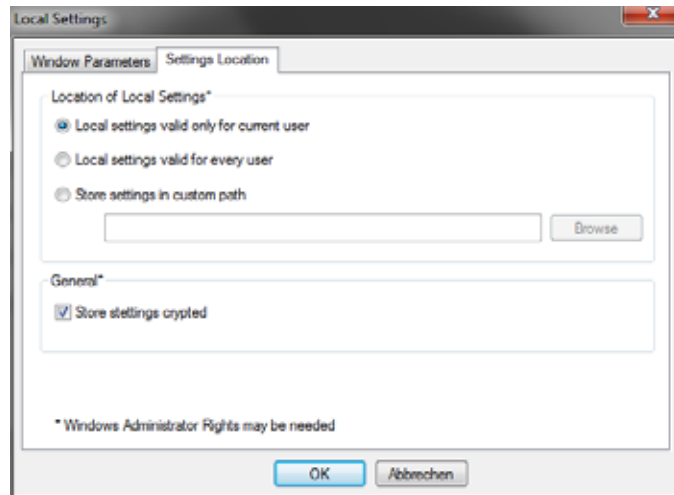

Settings location

- To store your settings only for the current user, select the option **Local settings only valid for current user**.
- To store the settings globally for all users, select the option **Local settings valid for every user**.
- Alternatively, you can select the option **Store settings in custom path** to define a specific folder in which your settings are stored.

General

- To store your settings encrypted, you can activate the option **Store settings encrypted**.

5.8 Menu Administration

FIG. 65 MENU ADMINISTRATION

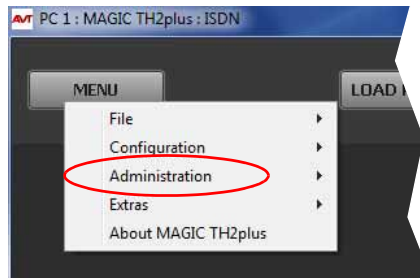

5.8.1 Submenu Registration

The serial number of the system as well as the enabled options are displayed under the submenu **Registration**.

FIG. 66 SUBMENU REGISTRATION

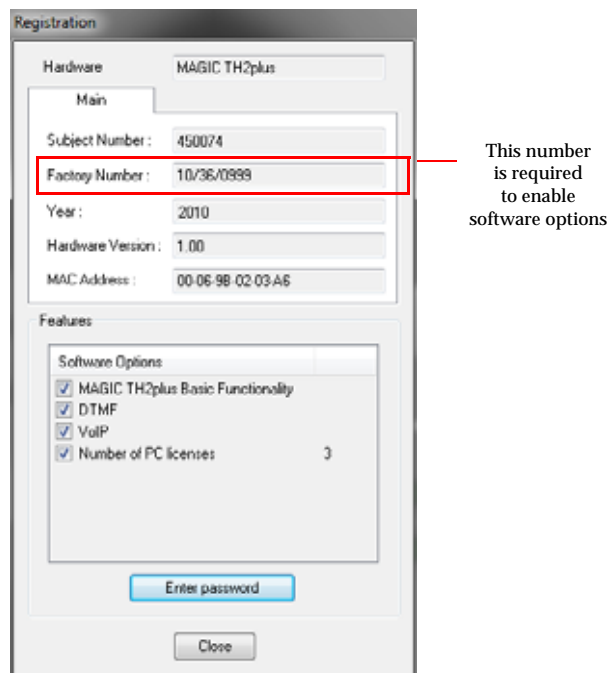

The system data includes the following information:

- **Hardware**
- **Subject Number**
- **Factory Number**
- **Year** of production
- **Hardware Version**
- **MAC Address**

Features

- Under **Features** the available and activated **Software Options** of the **MAGIC TH2plus** are displayed. The options listed here can be activated via a password. This password is assigned according to the **Factory Number**. If you bought an option supplementarily, please enter the password that you received from us under **Enter software option password**.

FIG. 67 PASSWORD ENTRY TO ENABLE AN OPTION

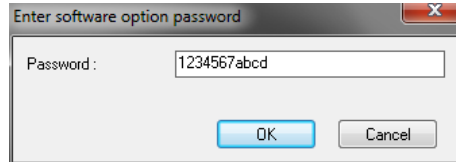

Subsequently, the system executes a warm start. Afterwards, the functions are activated.

ATTENTION Please enter the password carefully.



If you enter a wrong password **three times**, you must switch off the system and switch it on again.

5.8.2 Submenu File System

By selecting the submenu **File System** the file directory of the system (similar to the harddisk of a PC) is displayed.

ATTENTION Please do not carry out any actions under **File System** unless our support asked you to.



FIG. 68 SUBMENU FILE SYSTEM

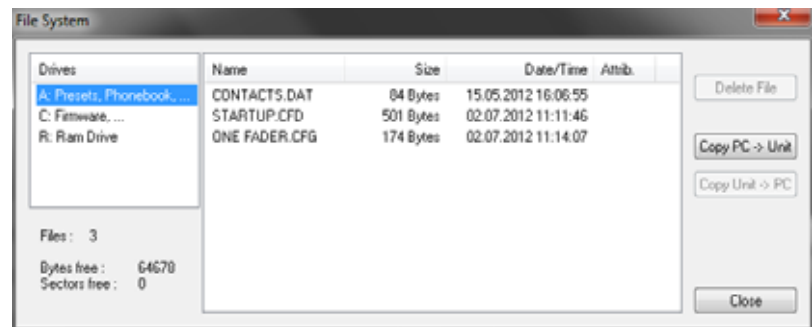

Via the button **Delete File** the currently selected file is deleted from the system.

ATTENTION Do not delete a file unless our service told you to delete the file. Otherwise a malfunction of the system can occur.



The button **Copy PC -> Unit** allows you to copy a file from a PC to the system.

ATTENTION Please use only the function **Firmware Download** (see CHAPTER 5.8.4) respectively the import function in the menu **File** (see CHAPTER 5.6) to copy files to the system.



The button **Copy Unit -> PC** allows you to copy a file from the system to the connected PC.

ATTENTION Please use only the export function under the menu **File** (see CHAPTER 5.6) to copy files to a PC.



5.8.3 Submenu System Panel

The **System Panel** is only for service purposes. Please enter only commands in the prompt, if our Support requests it from you.

FIG. 69 SUBMENU SYSTEM PANEL

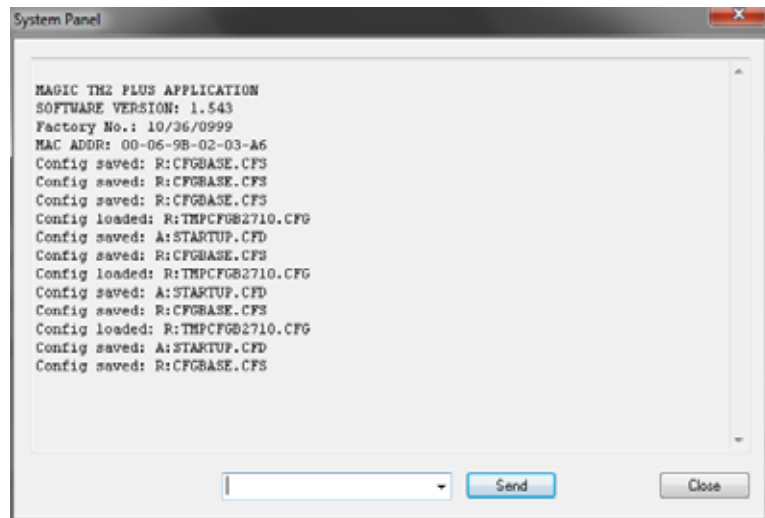

5.8.4 Submenu Firmware Download

The required firmware for the **MAGIC TH2plus** system is always included in the PC software: Via the **Firmware Download** you can comfortably download the firmware on your system.

By using the **Browse** button you select the firmware file. It is always located in the same directory in which you installed the **MAGIC TH2plus** application. The standard installation directory is:

C:\Program Files\MAGIC TH2plus

The file name of the firmware is „**th2plus.ssw**“.

FIG. 70 SUBMENU FIRMWARE DOWNLOAD

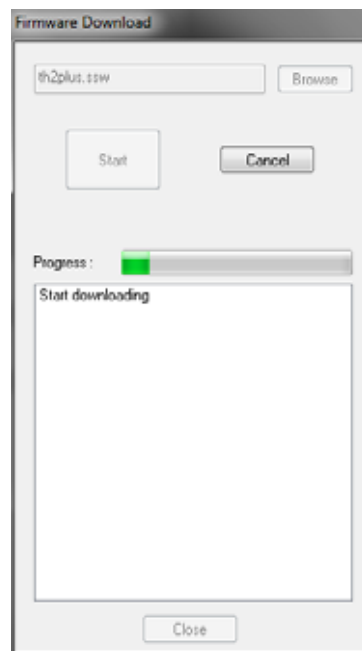

Please press the **Start** button to download the firmware. The **Progress** bar displays the progress of the download. The process is finished after about three minutes. If the download was successful, a corresponding message is displayed. After your confirmation the system is reset.

NOTE

If the download was not successful, you can simply switch off the unit and switch it on again. The new software is only written in the flash memory if the download was successful. Otherwise the old firmware is maintained.

5.8.5 Submenu Factory Settings

By using the submenu **Factory Settings** the system can be reset to the initial state.

For safety reasons you have to confirm your selection.

FIG. 71 CONFIRMATION LOAD FACTORY SETTINGS

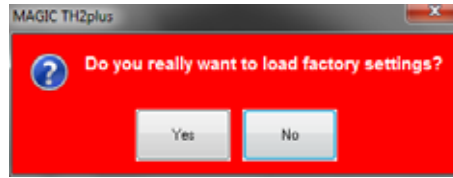

5.9 Menu Extras

FIG. 72 MENU EXTRAS

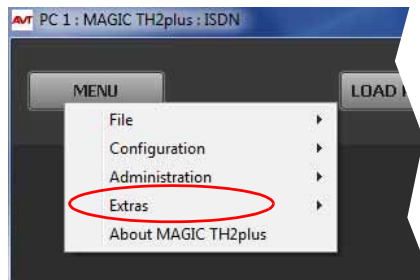

5.9.1 Submenu System Monitor

Via the menu **System Monitor** you receive information about the system status.

FIG. 73 SUBMENU SYSTEM MONITOR

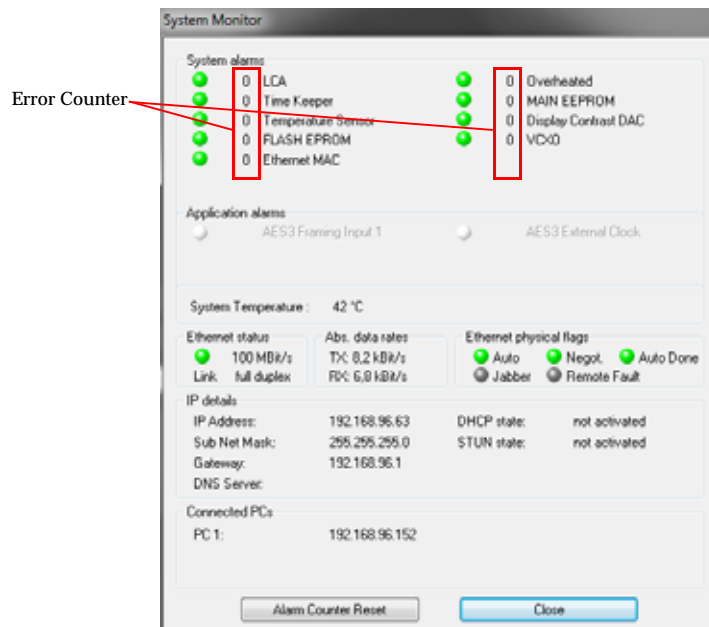

- Under **System alarms** all potential system alarms are displayed. A red LED signals a currently existing alarm. The error counter shows how often the alarm occurred after the unit has been connected to power.

NOTE

If an alarm occurs frequently or over a longer period disconnect the unit from electricity. If the error occurs again after switching on, there is probably a hardware defect.

The following errors are signalised:

- **LCA**: The communication with a programmable component is faulty.
- **Time Keeper**: The communication with the integrated clock module is faulty.
- **Temperature Sensor**: The communication with the temperature sensor is faulty.

- **FLASH EPROM:** The communication with the permanent memory is faulty. Configurations cannot be saved or read anymore.
- **Ethernet MAC:** The initialization of the ethernet module has failed.
- **Overheated:** The system sets this alarm if the system temperature is higher than 57°C. Disconnect the unit from electricity or cool down the ambient temperature.
- **MAIN EEPROM:** The communication with the permanent memory is faulty. Configurations cannot be saved or read anymore.
- **Display Contrast DAC:** The communication with the display contrast DAC is faulty.
- **VCXO:** The communication with the voltage-controlled oscillator is faulty.

TIP

A system alarm can also be configured as relay output (see Page 57).

- Under **Application alarms** you will find all potential application alarms. A red LED signalises a currently existing alarm. The error counter shows how often the alarm occurred after the unit has been connected to power.
 - **AES3 Framing Input 1:** If the digital Audio input is selected in the configuration dialogue, but no digital Audio signal is available at the **AUDIO 1/AES IN** interface, the **AES3 Framing Input 1** alarm will be set.
 - **Ethernet Mode Supported:** The Ethernet Mode alarm will be set if your ethernet mode is not supported by the system. This is the case for a 10 Mbit/s half duplex connection. Our recommendation is 100 Mbit/s full duplex.
 - **AES3 External Clock:** Currently not applicable.
- The actual system temperature is displayed in °C under **System Temperature**.
- **Ethernet status** shows information about your ethernet connection.
- Under **Abs. data rates** the absolute data rates of your ethernet connections are displayed. TX stands for transmit direction and RX for receive direction.
- Under **Ethernet physical flags** the following ethernet flags are displayed:
 - **Extended**
 - **Auto**
 - **Negot.**
 - **Jabber**
 - **Remote Fault**
- All details concerning the LAN and IP settings are displayed under **IP details**.
 - **IP Address**
 - **Sub Net Mask**
 - **Default Gateway**
 - **DNS Server**
 - **DHCP state**

- **STUN state**
- The IP address of the Control PC connected to the system is shown under **Connected PCs**.

5.10

Menu About MAGIC TH2plus

In the **About MAGIC TH2plus** dialogue you find the version of the PC software (**PC Version**) and the **Firmware Version**. Besides, you can find our contact details there.

FIG. 74 SUBMENU ABOUT MAGIC TH2PLUS



6 OPTION: DTMF TONE ANALYSER

With the fee-based option *DTMF¹ Tone Analyser Plug-In* you have the possibility to analyse DTMF tones. The sending of DTMF tones is a standard feature and included in the delivery scope.

6.1 DTMF system functions

6.1.1 DTMF call initiation via the Audio inputs

You can also initiate a call using DTMF tones via the Audio inputs of the system. You simply need to send the DTMF tones from an external DTMF generator to the Audio input of the *MAGIC TH2plus*. To signal the system that the number is complete, you need to send the dialling command via a TTL Pin (see Page 55, TTL Pin as input → Connect via DTMF/Accept Call In).

FIG. 75 DTMF CALL INITIATION VIA THE AUDIO INPUTS

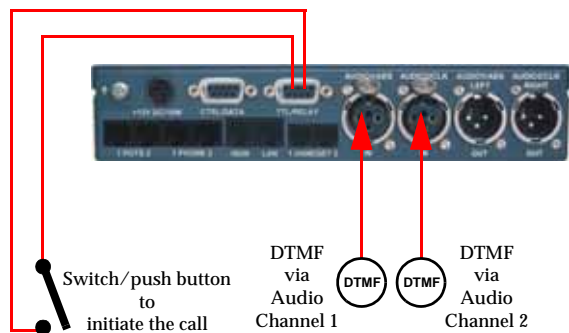

¹ DTMF = Dual Tone Multi-Frequency

6.2 DTMF PC Software functions

To configure the DTMF function via PC, select the submenu **Configuration** → **DTMF Settings**.

FIG. 76 DTMF SETTINGS

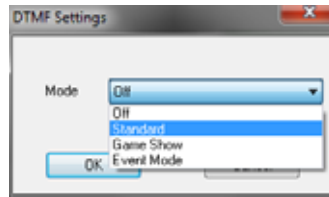

6.2.1 DTMF Modes

To activate the PC DTMF function, select **Standard**, **Game Show** or **Event Mode** under **Mode** and press **OK**. Subsequently, the DTMF buttons are displayed in the main window.

FIG. 77 MAIN WINDOW WITH ENABLED DTMF FUNCTION

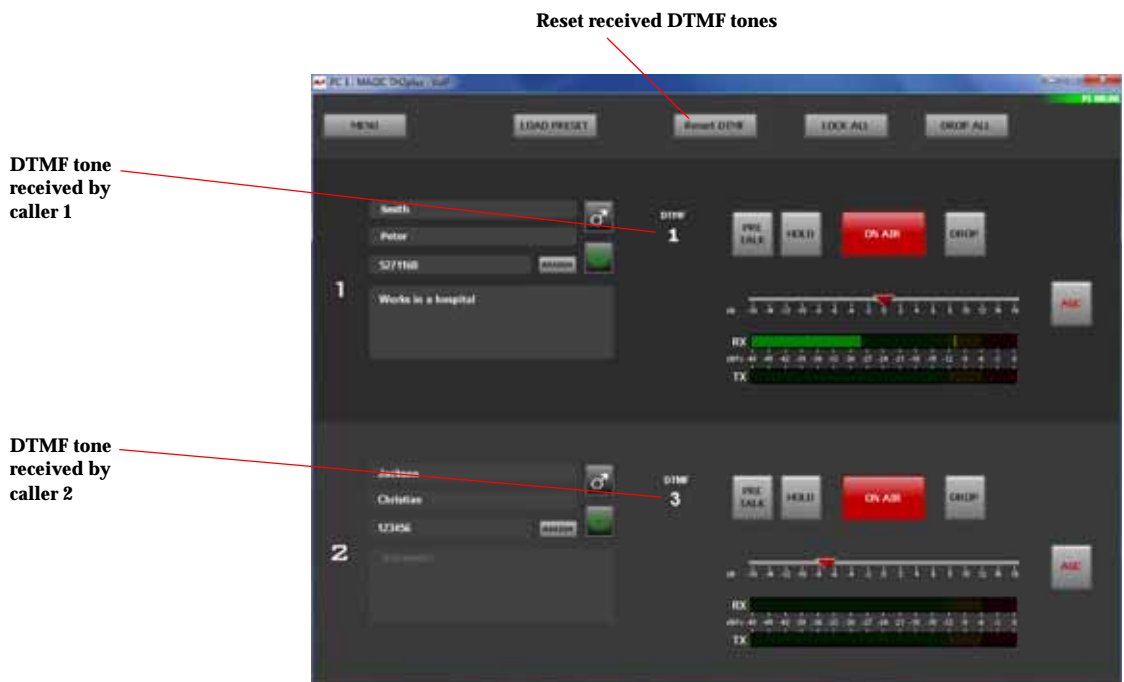

DTMF tone received by caller 1

DTMF tone received by caller 2



- (1) **Standard:** Each key pressed on the phone of the partner is displayed as cypher. The button **RESET DTMF** resets the display
- (2) **Game Show:** This configuration is useful if you play a game with two partners at the same time, in which you ask a question and the partners give their answers by pressing a key on their telephones. The partner who pressed the key first is displayed via a field marked in green and the cypher pressed. In this way, it is easy to determine who was the first

to give the right answer. A re-pressing of a key on the telephones of the partners is ignored by the system. A new analysis is not carried out before the button **RESET DTMF** is used and the display has been reset.

FIG. 78 DTMF GAME SHOW MODE



- (3) **Event Mode:** This Mode should be selected if you want the callers to signal you an event, e.g. you have two reporters in line commenting different sport matches. As soon as something important happens, you want to put the respective reporter On Air. If you select the Event Mode, you can define in the configuration so-called **DTMF Event Labels** for the number keys **0 - 9** and the special keys **#** and *****, e.g. **1** stands for **Goal**, **2** stands for **Penalty** etc. (see CHAPTER 5.7.2.1.5, Page 54). These labels will be displayed in addition to the DTMF tone received and the presenter can decide if he wants to switch the caller On Air

FIG. 79 DTMF EVENT MODE

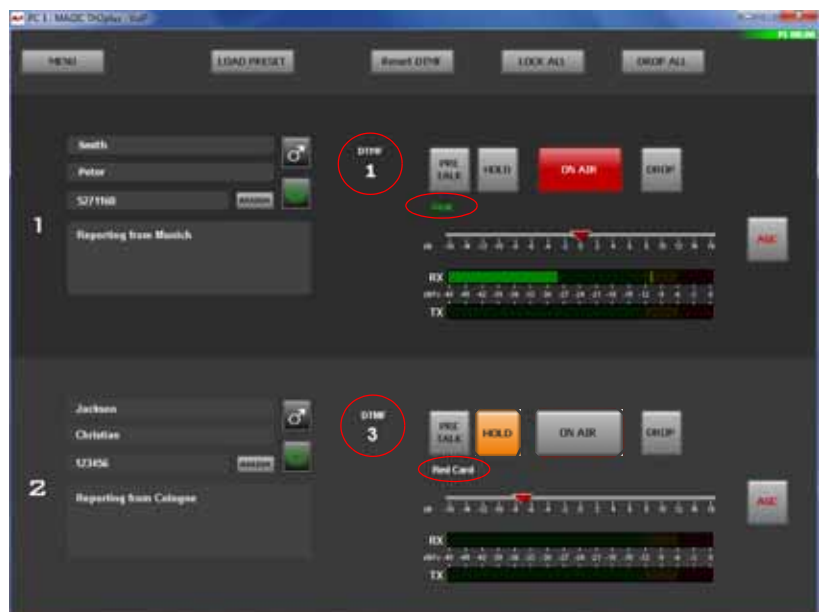

7 OPTION: MAGIC TH2PLUS KEYPAD

The optional **MAGIC TH2plus Keypad** enables users, who do not use a PC to operate the hybrid and who do not want to use the front display, to operate the system in an easy and comfortable way. You can connect up to **two MAGIC TH2plus Keypads** to the **MAGIC TH2plus**.

NOTE

To use the keypad with the **MAGIC TH2plus**, you must set the parameters for the RS232 interface to 9600 Baud, no parity. If you use the **QuickMenu** function you reach the settings of the RS232 parameters directly via the key sequence **Menu 15**. Please select **Keypad 9600, none**.

The following figure shows the operating elements of the Keypad.

FIG. 80 KEY ASSIGNMENT MAGIC TH2PLUS KEYPAD

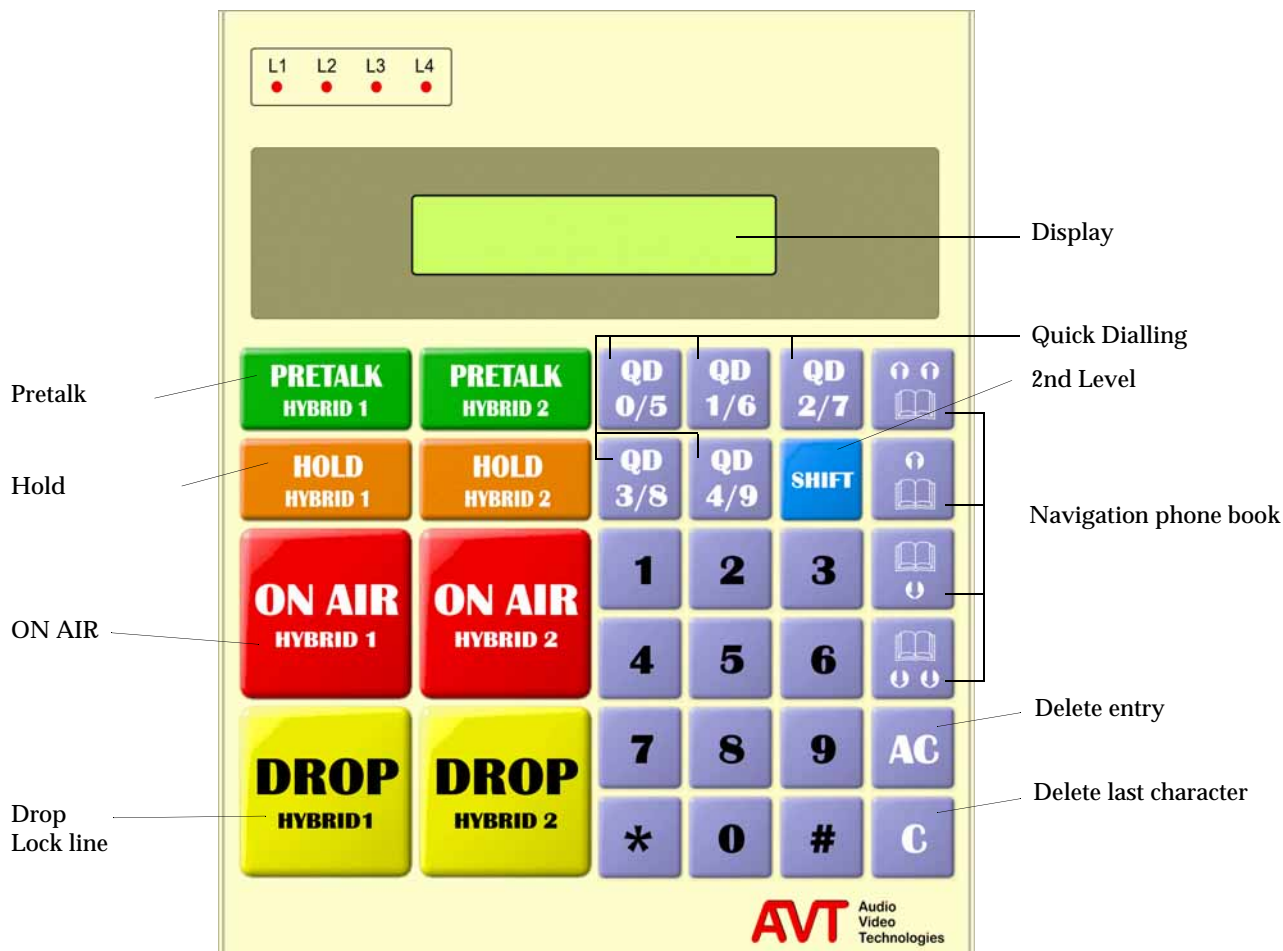

Please connect the 9-pole SUB-D connector of the **MAGIC TH2plus Hybrid Keypad** with the **RS232** interface (see CHAPTER A2.4, Page 119) of the **MAGIC TH2plus** System. Since the **MAGIC TH2plus Hybrid Keypad** requires its own power supply, please plug in the external power supply included in delivery and connect the 6-pole Mini-DIN socket of the external power supply with the 6-pole Mini-DIN connector of the **MAGIC TH2plus Hybrid Keypad**. If everything is connected correctly, the display is illuminated. After switching on¹ the system, the message you can see in our figures is displayed after booting.

1 → DISCON. 2 → DISCON.
INTERFACE: ISDN

The status of channel 1 is displayed on the left side and the status of channel 2 is displayed on the right side.

7.1

LCD Display

The LCD Display with 2 x 20 characters generally displays information about the current connection status of the available channels in the first line. The following indications are possible:

TAB. 1 OVERVIEW OF THE STATUS INDICATIONS OF THE 1. DISPLAY LINE

Display	Meaning
CALLING	Outgoing call
📞📞📞📞📞📞	Incoming call
DISCONNECT	No connection
ON AIR	Caller is in On Air mode
HOLD	Caller is in Hold mode
PRETALK	Caller is in Pre Talk mode
Locked	Line is locked

The second line changes according to the status of the function.

1 → DISCON. 2 → DISCON.
INTERFACE: ISDN

– If there is no connection, the selected operating mode ISDN or POTS is displayed.

1 → CALLING 2 → DISCON.
03012345678

– If a telephone number is entered, the second line displays the telephone number.

The phone number can be entered with the keys 0...9.

NOTE

The cypher last entered can be deleted by pressing the **C** button.

The entire entry is deleted by pressing the **AC** button.

1 → ON AIR 2 → DISCON.
← ■ ■ → ■

– During a connection it is possible to display a level meter instead of the phone number respectively the name. To shift please press the short-cut **SHIFT + 3**. The Audio level of the incoming caller signal (←) as well as the outgoing signal to the caller (→) is displayed.

The level meter covers the range from -34...+6 dB in 2 dB steps.

¹ If the system has already been switched on, please press the button „C“ or „AC“ once.









- If there is a connection error, the ISDN provides various alarm messages. Please see the following table for their meanings. The LCD display shows the relevant B channel first followed by the alarm message.

Alarm message	Description
Unass. number	The number is not recognised by the ISDN. Please check your entry
No route	No route. When this message appears the ISDN is normally overloaded. Please dial again.
Normal disc.	The connection has been cleared.
User busy	The number called is busy.
No user resp.	The called number is not responding. Possibly the wrong number was dialled.
Call rejected	The call was rejected. Possibly the partner has rejected your call.
Number chang.	The dialled number has been changed.
Destin. error	The called end is not operational. Maybe the unit is switched off.
Inval. number	Invalid Number.
No line avai.	No B channel available.
No Network	No ISDN available. Check your ISDN line.
Netw. failure	Temporary ISDN failure.
Congestion	ISDN network error. Maybe the wrong ISDN protocol is selected.
Bearer capab.	The wanted service is not available.
Bearer serv.	The wanted service is not implemented.
Remote disc.	Connection has been dropped by the partner
Procedure er.	Remote or local ISDN procedure error.
Cannot dial	System cannot dial.

7.2



Keypad Functions

Below you will find the keypad functions listed in table form.

TAB. 3 KEYPAD FUNCTIONS	
Function key	Description
	After pressing the key the last cypher of an entry is deleted. Partly, this key is used to terminate an operation.
	By pressing this key you can delete the entire entry.
	Via the keys 0...9 it is possible to enter a phone number. The connection is established by pressing the button PRETALK, HOLD or ON AIR of the respective channel.
	The keys '*' and '#' are mostly used for special functions in connection with a private branch exchange.
	By pressing the Quick Dial keys QD 0 ... QD 4 a pre-programmed number is dialled immediately. The storage of the telephone number can be carried out via the PC Software (see CHAPTER , Page 37) or via the Keypad itself. The shift to the second level is carried out by the SHIFT key. Programming of a Quick Dial key: - Entering the phone number - Pressing SHIFT + 3 - Selecting the desired Quick Dial key
	The SHIFT key allows a shifting to the 2. Quick Dial Keys level. If the SHIFT key is pressed the character '^' is displayed in the upper right corner. Additionally, the following special function are programmed: SHIFT + 1: Activating/Deactivating the sending of DTMF tones in channel 1 ^a SHIFT + 2: Activating/Deactivating the sending of DTMF tones in channel 2 SHIFT + 3: Programming of the Quick Dial keys SHIFT + 4: not used SHIFT + 5: Display of the software version SHIFT + 6: Shift display of phone number (name)/ display of level meter
	Via these two keys you can scroll 5 entries upwards respectively downwards in the phone book.
	Via these two keys you can scroll 1 entry upwards respectively downwards in the phone book.
	This button drops the connection of the respective channel. There is no request for confirmation. If no connection exists the line can be locked by pressing the key. Now the status LOCKED is displayed. The line is unlocked by pressing the key a second time. This function is only available in the ISDN operating mode.

1 → DISCON. 2 → DISCON. ^
0 3 0 1 2 3 4 5 6 7 8

TAB. 3 KEYPAD FUNCTIONS

Function key	Description
	<p>The caller on the respective channel is set in the PRETALK mode.</p> <p>The PRETALK can be carried out via the handset or in the analogue POTS operating mode via a standard telephone.</p> <p>If a caller on the other channel is already in PRETALK, he is set automatically in HOLD mode.</p>
	<p>The caller is set in the HOLD mode.</p> <p>The signal which the caller listens to in this status can be set via the PC Software (see CHAPTER , Page 37).</p>
	<p>The caller on the corresponding channel is set in the ON AIR mode.</p> <p>The caller signal can be heard on the corresponding Audio line Audio 1/2 OUT. There is no mixing of the two callers.</p>

1*DISCON. 2→DISCON.^
03012345678

- a A * is displayed behind the channel number if the sending of DTMF tones is activated. To send DTMF tones, the fee-based option **DTMF** must be enabled.

A 1 MENU STRUCTURE

On the following pages you will find the complete menu structure if you select **English** as your menu language.

From the main menu you reach the phone book directly via the softkey **Names**. If you use the softkey **Menu** you go to the configuration of the system.

The configuration menu again is divided into five submenus:

- System Settings
- Operation Settings
- Presets
- Status Information
- Login

NOTE

Please notice that some menu items may not be displayed depending on the selected operating mode.

If you use an Administrator and/or a User Password, the display looks as it is described below:

- (1) Only **Administrator Password** configured: The password must be entered for changes to the **System Settings** and **Operation Settings** only. Immediately available menus:
 - Presets
 - Status Information
 - Login
- (2) Only **User Password** configured (instead of **Menu**, **Login** is displayed): The password must always be entered. Subsequently, all menus are available.
- (3) **Administrator** and **User Password** configured (instead of **Menu**, **Login** is displayed):
 - **User Password** is entered: The menus **Presets**, **Status Information** and **Login** are available
 - **Administrator Password** is entered: All menus are available.

NOTICE

There is no differentiation between upper and lower case for the password entry.

A1.1

System Settings - ISDN

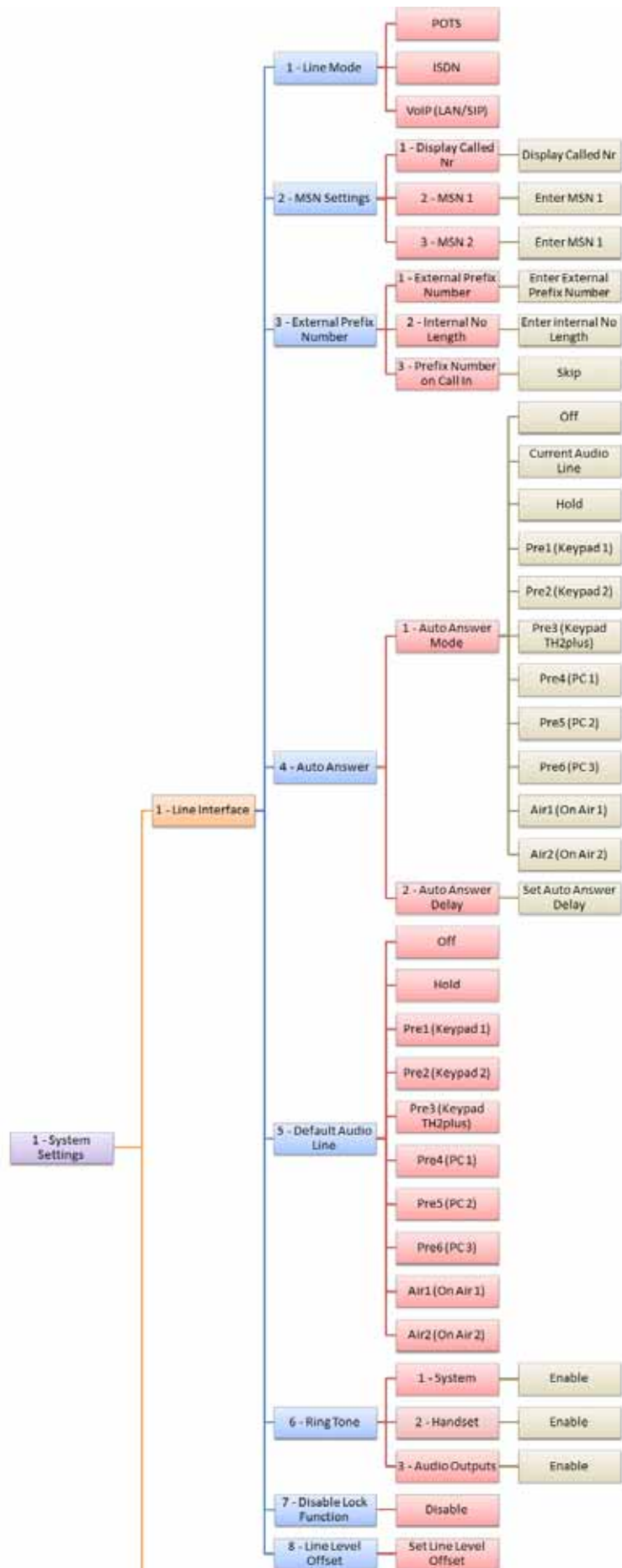

See next page

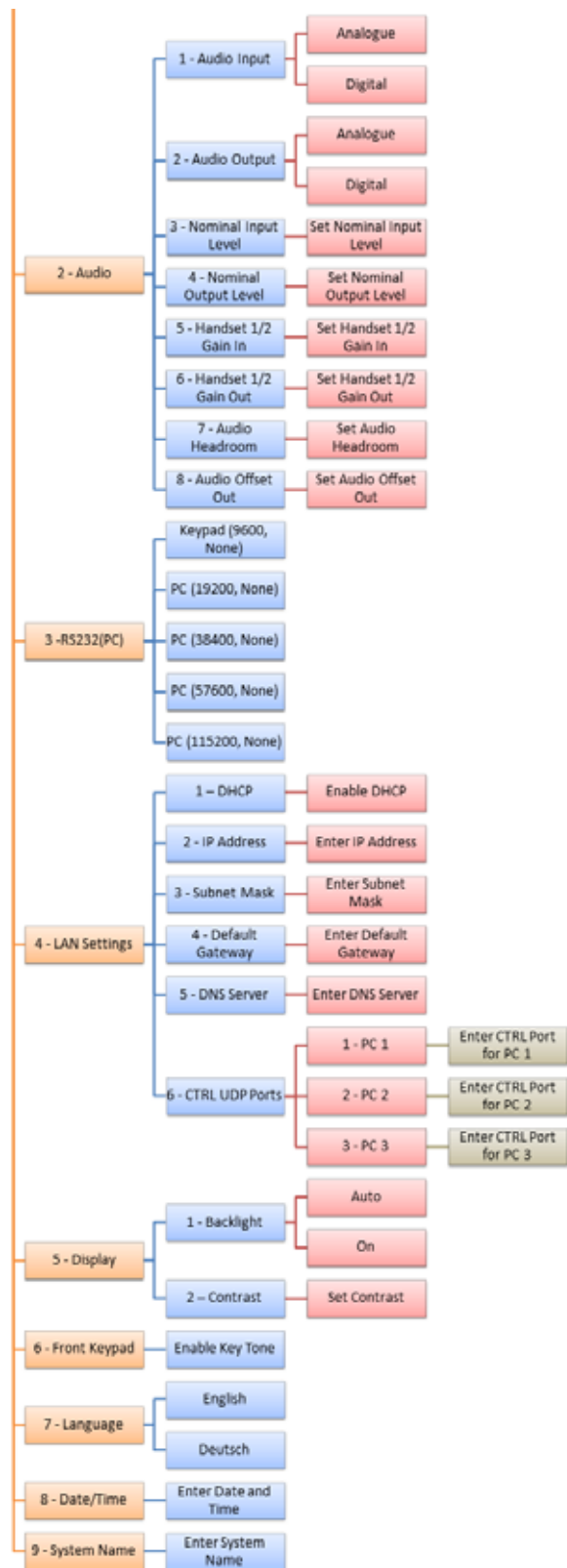

A1.2 System Settings - POTS

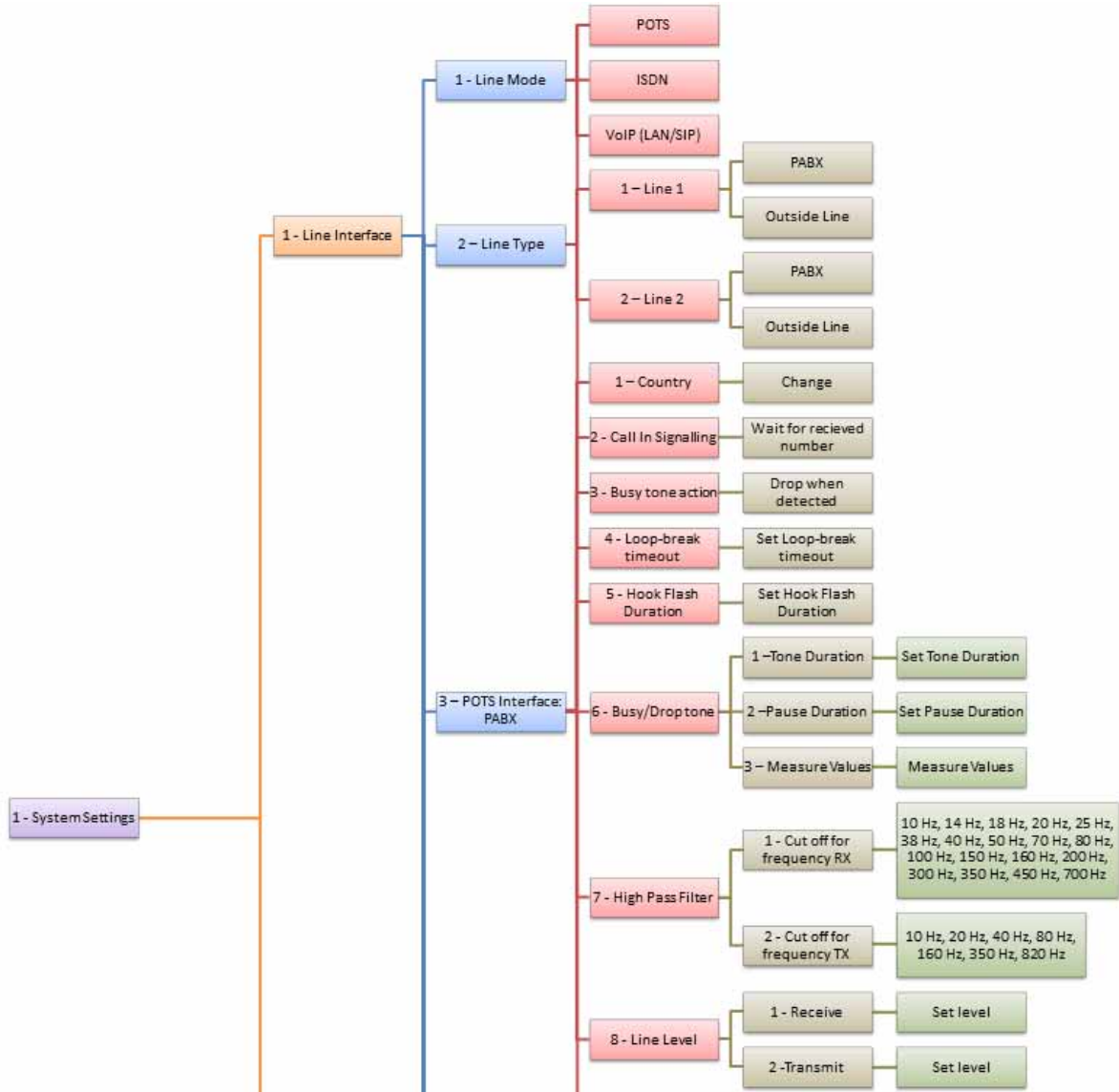

See next page

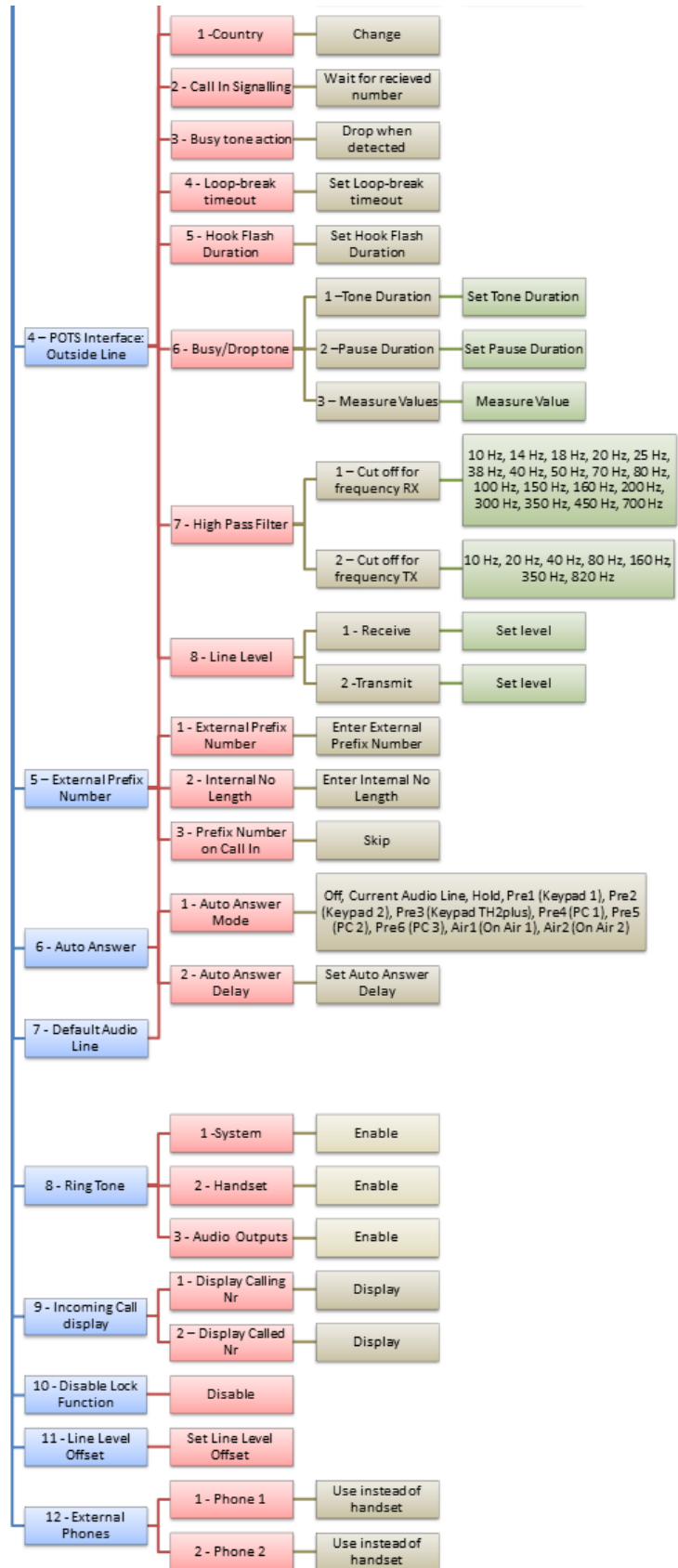

See next page

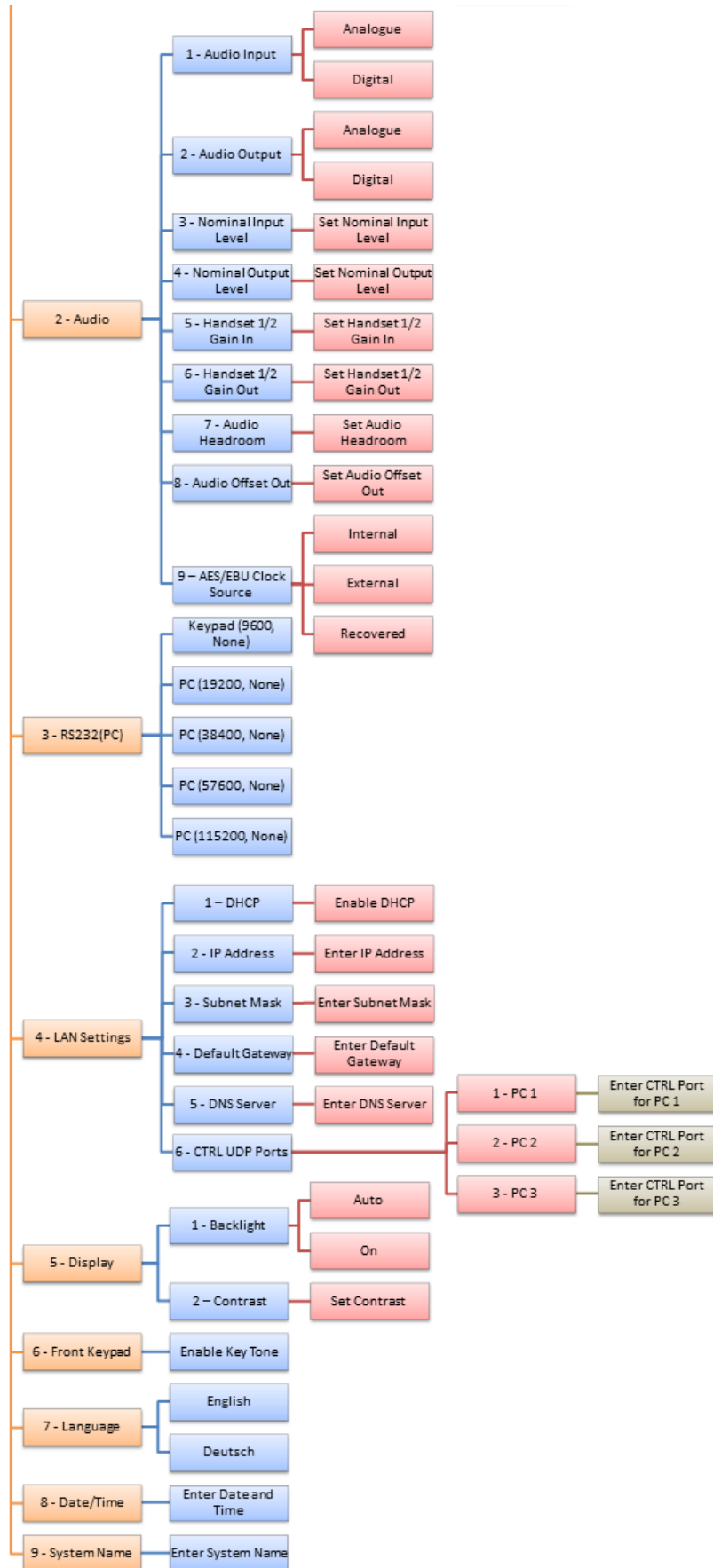

A1.3

Operation Settings

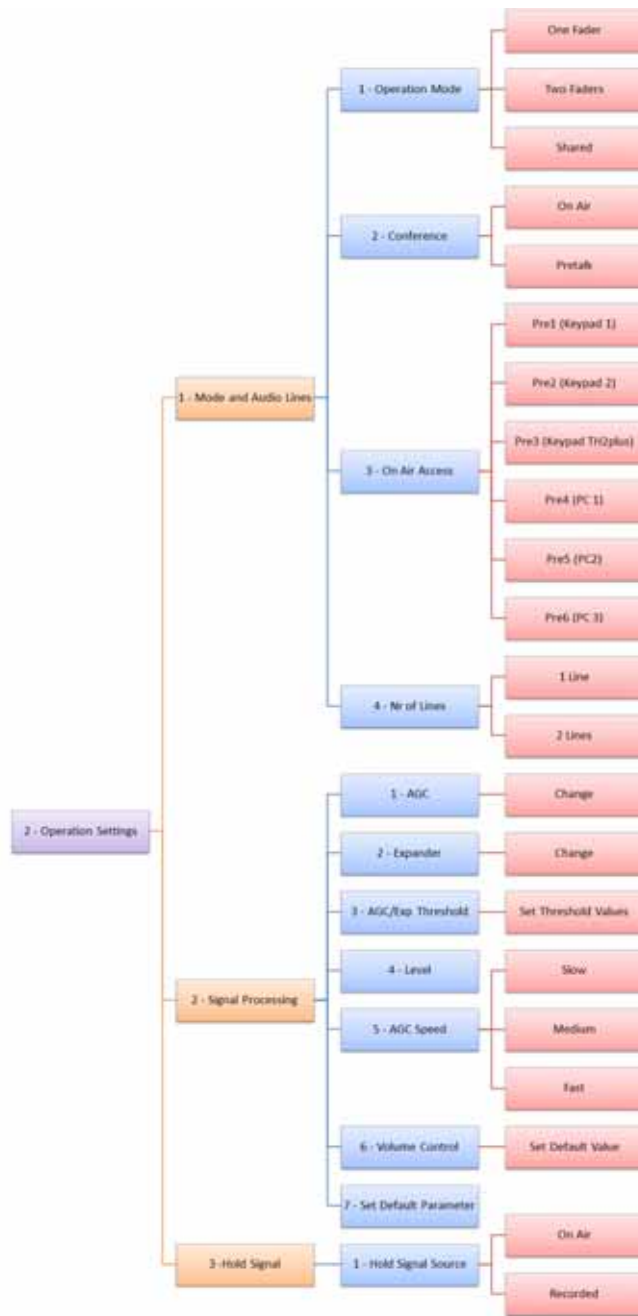

A1.4

Presets



A1.5

Status information



A1.6

Login

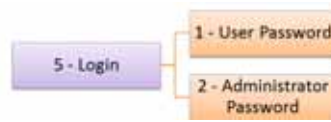

A 2 INTERFACES

The interfaces of the systems are pictured in Fig. 81.

FIG. 81 REAR VIEW OF THE MAGIC TH2PLUS TELEPHONE HYBRID



FIG. 82 REAR VIEW OF THE MAGIC TH2PLUS RM TELEPHONE HYBRID



All interfaces are described below.

A2.1 POTS, ISDN and LAN interfaces

A2.1.1 POTS 1 & 2 interfaces

These interfaces are used to connect the system to analogue telephone lines.

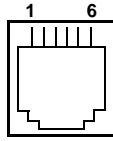

TAB. 4 PIN ASSIGNMENT: POTS TELEPHONE INTERFACE (LINE POTS)

Socket: Western (6 pin) RJ12		
Pin	Signal	Electrical characteristics
1	not used	Typical characteristics: Bandwidth: 300 - 3.3 kHz Signal to noise ratio: 45 dB Average level: -9 dBm (275 mV) Impedance: 600 ohms DC voltage: 48 V (±6 V typ) DC current: 20-26 mA (typ) Ringing voltage: 90 Vrms Ringing frequency: 20 Hz (2 sec on, 4 sec off)
2	not used	
3	TEL LINE a	
4	TEL LINE b	
5	not used	
6	not used	

A2.1.2 S₀ interface

This interface supports two B channels in ISDN networks with the EURO ISDN (DSS-1), the US National-1 or the Japanese ISDN Protocol.

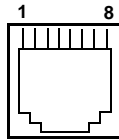

TAB. 5 PIN ASSIGNMENT: S₀ INTERFACE (LINE ISDN)

Socket: Western (8 pin) RJ45		
Pin	Signal	Electrical characteristics
1	not used	Recommendation: I.430 Data rate: B channel: 2x64 kbit/s D channel: 16 kbit/s
2	not used	
3	TX a Data out a	
4	RX a Data in a	
5	RX b Data in b	
6	TX b Data out b	
7	not used	
8	not used	

A2.1.3 LAN interface

Via this interface you can control the system via a PC. If the fee-based software option *Extension for Voice over IP (ID: 430399)* is enabled, you can connect your system to a LAN network for VoIP.

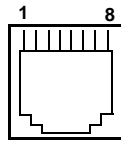

TAB. 6 PIN ASSIGNMENT: LAN INTERFACE (CONTROL + VOIP)

Socket: Western (8 pin) RJ45			
Pin	Signal		Electrical characteristics
1	TX+	Data out +	Recommendation: IEEE 802.3/Ethernet
2	TX-	Data out -	Data rate (automatic): 10BaseT (10 Mbit/s) 100BaseTX (100 MBit/s)
3	RX+	Data in +	
4	not used		Recommended cable: CAT5
5	not used		Maximum cable length: 100m
6	RX-	Data in -	
7	not used		
8	not used		

A2.2 PRETALK interfaces

A2.2.1 HANDSET 1 & 2 interfaces

To these interfaces you can connect a telephone handset/headset for the PRETALK.

ATTENTION Pin assignment not standardised



Please note that the Pin assignment of the telephone receivers is not standardised. Additionally, it is important to consider the correct polarity of the Phantom Power.

MAGIC TH2plus Telephone Handsets and **MAGIC TH2plus Telephone Headsets** are optionally available.

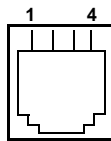

TAB. 7 PIN ASSIGNMENT: HANDSET/HEADSET INTERFACE (HANDSET)

Socket: Western (4 pin) RJ10

Pin	Signal	Electrical characteristics
1	HANDSET IN a/+5V phantom power	Microphone: Impedance: ~ 2 kOhm
2	HANDSET OUT b (GND)	Sensitivity: ~ -60 dB @ 1-kHz
3	HANDSET OUT a	Telephone receiver: Impedance: ~150 Ohm
4	HANDSET IN b	Sensitivity: ~ 97dB @ 1-kHz

A2.2.2 PHONE 1 & 2 interfaces

In the POTS operating mode, you can connect a POTS Telephone for PRETALK and dialling to these interfaces.

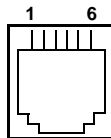

TAB. 8 PIN ASSIGNMENT: POTS TELEPHONE INTERFACE (PHONE)

Socket: Western (6 pin) RJ12

Pin	Signal	Electrical characteristics
1	not used	
2	not used	
3	TEL LINE a	
4	TEL LINE b	
5	not used	
6	not used	

A2.3

Audio interfaces

The system incorporates analogue and digital AES/EBU Audio interfaces. The interfaces can be configured via the front display and keypad or via the PC software.

A2.3.1

Analogue Audio interface

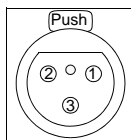

TAB. 9 PIN ASSIGNMENT: ANALOGUE INPUT (AUDIO 1/2 IN)

Socket: XLR		
Pin	Signal	Electrical characteristics
1	Analogue GND	Incoming level: adjustable -3 +9 dBu
2	AUDIO IN a	Impedance: > 25 kΩ
3	AUDIO IN b	Head room: 6 dB

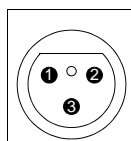

TAB. 10 PIN ASSIGNMENT: ANALOGUE OUTPUT (AUDIO 1/2 OUT)

Connector: XLR		
Pin	Signal	Electrical characteristics
1	Analogue GND	Outgoing level: adjustable -3 +9 dBu
2	AUDIO OUT a	Impedance: 50 Ω
3	AUDIO OUT b	Head room: 6 dB

A2.3.2

Digital AES/EBU Audio interface

The *MAGIC TH2plus* Telephone Hybrid incorporates two digital Inputs/Outputs which are physically one AES/EBU interface. The input has a digital sample rate converter providing that a digital source with 32, 44.1 or 48-kHz can be connected directly. For external clocking (48-kHz only) the word clock input or output may be used.

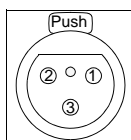

TAB. 11 PIN ASSIGNMENT: DIGITAL INPUT (AES IN)

Socket: XLR		
Pin	Signal	Electrical characteristics
1	Analogue GND	IEC-958
2	AUDIO IN a	
3	AUDIO IN b	

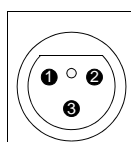

TAB. 12 PIN ASSIGNMENT: DIGITAL OUTPUT (AES OUT)

Connector: XLR		
Pin	Signal	Electrical characteristics
1	Analogue GND	IEC-958
2	AUDIO OUT a	
3	AUDIO OUT b	

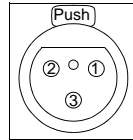

TAB. 13 PIN ASSIGNMENT: CLOCK INPUT (CLK IN)

Socket: XLR

Pin	Signal	Electrical characteristics
1	Analogue GND	TTL
2	CLOCK IN	
3	not used	

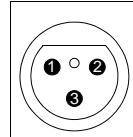

TAB. 14 PIN ASSIGNMENT: CLOCK OUTPUT (CLK OUT)

Connector: XLR

Pin	Signal	Electrical characteristics
1	Analogue GND	TTL
2	CLOCK OUT	
3	not used	

A2.4 Control Interface

A2.4.1 LAN interface

Please see A2.1.3, Page 115.

A2.4.2 Keypad 1,2 interface

To this interface you can connect an external **MAGIC TH2plus Keypad** to control the system. If you want to connect two Keypads simultaneously, you need an adapter cable. Alternatively, if you don't want to use the LAN interface to connect a PC to **MAGIC TH2plus**, you can also use the RS232 interface. To connect a PC you need a 1:1 connecting cable, in which Pin 2 and Pin 3 are **not** crossed. Additionally, Pin 5 GND must be connected. The remaining Pins are not used.

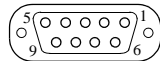

TAB. 15 PIN ASSIGNMENT: KEYPAD INTERFACE (RS232)

Socket: SUB-D (9 pin)		
Pin	Signal	Electrical characteristics
1	not used	Type: DCE ^a Level: V.24
2	TXD Keypad 1 OUT	Data rate: 38400 Baud
3	RXD Keypad 1 IN	Range: max. 15 m
4	not used	Protocol: 1 Start bit 8 Data bits 1 Stop bit
5	GND Earth	
6	not used	
7	RXD Keypad 2 IN	
8	TXD Keypad 2 OUT	
9	not used	

a DCE = Data Communication Equipment: to connect a PC a 1:1 cable is required

A2.4.3 TTL/RELAY interface

Via this interface external control signals can be used.

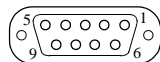

TAB. 16 PIN ASSIGNMENT: TTL/RELAY INTERFACE (TTL/RELAY)

Socket: SUB-D (9 pin)		
Pin	Signal	Electrical characteristics
1	TTL 1 IN/OUT	Capacity of the TTL inputs/outputs: Maximum voltage: 3.3 V Maximum current: 10mA
2	TTL 2 IN/OUT	
3	TTL 3 IN/OUT	
4	TTL 4IN/OUT	
5	GND	
6	Relay 1a	Capacity of the relays: Maximum voltage: 48V Maximum current: 200mA
7	Relay 1b	
8	Relay 2a	
9	Relay 2b	

A2.5

Power supply interface

The power supply is connected via an external power supply adapter.

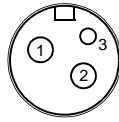

TAB. 17 PIN ASSIGNMENT: POWER SUPPLY

Socket: KYCO KPJ-S3

Pin	Signal	Electrical characteristics
1	GND	Voltage: +12V
2	+12V	Power: max. 15W
3	not used	

A 3 TECHNICAL DATA MAGIC TH2PLUS

CODING ALGORITHMS

- G.711 A-Law 3,1-kHz (Telephone algorithm)
- G.722 (optional with HD Voice Upgrade in VoIP mode)

LINE INTERFACES:

- ISDN
 - 1 x S₀ I.430 RJ45
 - Protocol DSS-1, NI-1, Japanese ISDN
- POTS
 - 2 x POTS RJ12
- LAN
 - 1 x LAN RJ45

PRETALK INTERFACES

- Handset/Headset interface
 - 2 x HANDSET RJ10
- Telephone interface
 - 2 x PHONE RJ12

CONTROL INTERFACES

- LAN RJ45
- RS232 V.24 9 pin SUB-D socket
- TTL/RELAY 9 pin SUB-D socket
 - 2 x Relay Capacity 48V/200mA function can be programmed
 - 4x TTL Input/Output Capacity 3.3V/10mA function can be programmed

AUDIO INTERFACES

Analogue Audio 1/2:

- Electronically balanced input XLR female
- Electronically balanced input XLR male
- Nominal level -3 ... +9 dBu (can be programmed)
- Head room 0 ... 15 dB (can be programmed)
- Impedance Input: > 25 k Ω
Output: 50 Ω
- Frequency response 50 Hz ... 3400 Hz
- Signal to Noise Ratio > 80 dB
- Noise - 92 dB

Digital Audio AES/EBU:

- Format IEC-958 AES/EBU Professional
- Balanced input XLR female
- Balanced output XLR male
- Impedance Input: 110 Ω
Output: 110 Ω
- Clock input TTL/75 Ω XLR female
- Clock output TTL/75 Ω XLR male
- Separate Sample Rate Converter for Inputs

Handset/Headset:

- Electronically balanced input RJ10 socket
- Electronically balanced output RJ10 socket
- Input amplifier ~ 10 dB
- Gain In 0 ... +45 dB (can be programmed)
- Gain Out 0 ... +45 dB (can be programmed)
- Impedance Input: > 25 k Ω
Output: < 50 Ω

SIGNAL PROCESSING

- AGC per channel, configurable
- Level adjustment control during connection: -16 dB ... +16 dB

- Echo Canceller per channel (100 msec echo cancelling time)
- Expander per channel, configurable

DISPLAY

- graphical resolution 160 x 32 Pixel
- illuminated (can be switched off)

POWER SUPPLY VIA EXTERNAL ADAPTER

Direct Voltage (DC)

- + 12 V

Power Consumption

- max. 15 W

DIMENSIONS

H x W x D

- 44 x 220 x 220 mm

WEIGHT

- ca. 1,7 kg

ADDITIONAL INFORMATION

EMC

- EN 55103

Electric safety

- EN 60950

Temperature Range

- +5 °C to 45 °C

Relative humidity

- 5% is 85%

A 4 TECHNICAL DATA MAGIC TH2PLUS KEYPAD

A4.1 Keypad

Matrix: 8 x 6
 (32 keys 4 quad keys, 4 double keys, 24 single keys)

FIG. 83 CONNECTING CABLE MAGIC SYSTEM - KEYPAD

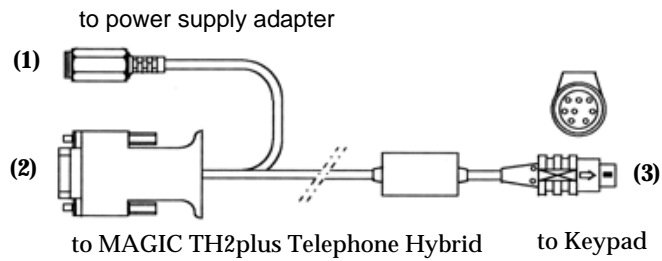

Protocol:

9600 Baud
 no parity

Connection to external power supply adapter (1):

6-pol. Mini-DIN connector

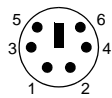

Assignment:

Pin 3: GND (Ground)
 Pin 4: +5V

Connection to MAGIC TH2plus (2):

9-pol. SUB-D connector

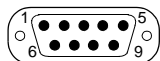

Assignment:

Pin 2: RXD
 Pin 3: TXD
 Pin 5: GND (Ground)

Connection to keypad (3):

8-pol. MINI DIN connector

Assignment:

Pin 2: clock
 Pin 3: +5V
 Pin 4: Data
 Pin 5: GND (Ground)

A4.2 LCD Display

2 x 20 characters

illuminated

A4.3 Power supply:

5V, max. 500 mA

Connection:

6-pol. Mini-DIN socket

Assignment:

Pin 3: GND (Ground)
 Pin 4: +5V

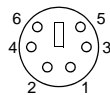

A 5 GENERAL

A5.1

Order numbers

MAGIC TH2plus Telephone Hybrid	802000
--------------------------------	--------

Accessories

MAGIC TH2plus Hybrid Keypad	802001
-----------------------------	--------

MAGIC TH2plus DUAL 19" Mounting Kit	802002
-------------------------------------	--------

MAGIC TH2plus Telephone Handset with Handset Rest	802003
--	--------

MAGIC TH2plus Telephone Headset	802004
---------------------------------	--------

POTS Telephone with Display ¹	490101
--	--------

GSM Adapter ¹	490135
--------------------------	--------

Portable Case	490152
---------------	--------

Software Options

Extension for Voice over IP	430399
-----------------------------	--------

MAGIC TH2plus Software Licence (one is included in delivery, 3 max.)	430396
---	--------

DTMF Generator & Analyser Plug-In	430200
-----------------------------------	--------

HD Voice Upgrade	430465
------------------	--------

¹ can only be used in POTS operating mode

A5.2 **Scope of delivery**

- MAGIC TH2plus Telephone Hybrid
 - CD Windows PC Software
 - External Power Supply Adapter
 - Input: 100 - 240V/24W, 50 - 60 Hz
 - Output: 12V
 - Self adhesive feet
 - 19" Mounting brackets
 - Manual
 - 1 x S₀ cable
 - 2 x POTS telephone cable

A5.3 **Declaration of conformity**

The declaration of conformity you will find at the end of this manual.

A 6 SERVICE INFORMATION

A6.1 Software Updates

On our homepage you can download software updates for free. Go to

<http://www.avt-nbg.de>

and select **Download - Software**.

A6.2 Support

You can contact our Support Hotline during the normal office hours between 09.00h - 17.00h (GMT+1) under the following telephone number:

+49 911 5271 160

or via E-Mail under

support@avt-nbg.de

To deal with your problem efficiently please note the factory number of the unit as well as the software version that you use.

A6.3 Repairs

If, contrary to expectations, your unit is defective please fill in the attached status report and send the unit to the following address:

**AVT Audio Video Technologies GmbH
- Repairs -
Nordostpark 12
D-90411 Nuernberg
Germany**

INDEX

Symbols

34
 * 34
 .T2P 79

Numerics

0 34
 1 U 15
 19" rack 15
 19" version 11
 9 34

A

ABC 31
 About MAGIC TH2plus 92
 Accept Call In 55
 Administrator 76, 103
 AES/EBU 17, 29, 70, 117
 AES/EBU Interface 70
 AGC 17, 30, 43, 52, 53, 122
 Air Humidity 19
 Alarm 89, 90
 Always closed 59
 Always open 59
 Ambient temperature 19
 Analogue 29, 70
 Analysis 95
 Any 57, 58
 Any System Alarm Pending 58
 Application alarm 90
 Application Alarm Pending 58
 Assign button 40
 Audible disturbance 69
 Audio 1 51
 Audio 1/AES IN 70
 Audio 2/CLK IN 70
 Audio 2/CLK OUT 70
 Audio coding 17
 Audio Headroom 71
 Audio Input 70, 93
 Audio Interface 49
 Audio Line 49, 55, 56, 57
 Audio line 30
 Audio Line Assignment 39, 49
 Audio Output 70
 Audio UDP Port 68

Auto 60
 Automatic Gain Control 43
 AVT Service 75

B

B Channel 114
 Backlight 60
 Basic Settings 27, 39
 Browse 87
 buffer 68
 Busy 39
 BUSY/DROP Tone 66

C

Cabling 21
 Call forwarding 42
 Call Out 55
 Called Number 58
 Called Number Labels 64
 Caller database 53
 Caller Screening 40
 Callin 31
 Calling 57
 CE Conformity 135
 Clock 70
 Clock input 122
 Clock output 122
 Clock Source of digital output 70
 Coding algorithms 121
 Coloured front keypad 11, 48
 COM Interface 61
 COM Port 46
 Configuration 32, 35, 39, 77, 78, 94, 103
 Confirm Password 76
 Connect 57
 Connect via DTMF 56
 Connection Status 57
 Contact information 92
 Contrast 60
 Control Interface List 46
 Control UDP Port Addresses 73
 Country Setting 66
 Cursor 32
 Custom Label 50

D

Database *40, 54*
 Database Path *54*
 Date/Time *32*
 Declaration of Conformity *127, 135*
 Decoder Buffer Mode *68*
 Decoder Buffer Size *69*
 Default Settings *50, 53*
 Default Value *53*
 Delay *68, 69*
 Delete *30, 31, 33, 79*
 Delete Entry *32*
 Delivery *127*
 DHCP *45*
 Dialing window *41*
 Digital *29, 70*
 Dimensions *123*
 Direction *55*
 Disable Lock Function *62*
 Disable lock function *38*
 Disconnect *57*
 Display *17, 18, 60, 117*
 Display called number on incoming call *64*
 Display Contrast DAC *90*
 Display illumination *27*
 Disturbance *69*
 Download *87*
 DROP *39*
 DROP ALL *38*
 Drop when busy tone detected *66*
 Dropping *30, 31*
 DSS-1 *114*
 DTMF *34, 80, 93, 94*
 DTMF Event Labels *54, 95*
 DTMF Settings *43, 80, 94*
 DTMF Tone Generation & Analyzer Plug-In *43*
 Dual Mounting Kit *15*

E

Earthing *19, 20, 21*
 Echo Cancellor *17, 52, 66, 123*
 Edge change *55*
 Edit *32, 79*
 Edit Caller Entry *40*
 E-Mail *128*
 EMC *20, 21, 123*
 Enable Auto Answer *63*
 Enable Ringing Tone on Handset/Headset *62*
 Enable System Ringing Tone *62*
 Enabled *60*
 Encoder Packet Size *69*
 English *60, 103*
 Enter software option password

84

EURO ISDN *114*
 Euro ISDN *62*
 Event Mode *95*
 Exit *44*
 Expander *17, 52, 123*
 Export *80*
 Export All *80*
 Ext. Phone *39*
 External *70*
 External phone *61*
 External Power Supply *37, 120*
 External prefix number *63*
 Extras *77*

F

Factory Number *83*
 Factory Settings *88*
 Fast *53*
 Features *84*
 Female *39, 42*
 Firmware *36, 87*
 Firmware Version *92*
 First Name *38*
 Fixed Low *57*
 Fixed to High (5V) *57*
 FLASH EPROM *90*
 Flash memory *87*
 FLASH-EPROM *51*
 Frequency response *122*
 Front Call Control *48*
 Front Keypad *18, 60*
 Front View *15*
 Function Code *55, 57, 59*
 Function key *100*

G

G.711 *17*
 Gain In *71*
 Gain Out *71*
 Game Show *94*
 German *60*
 GPIO *55*
 GSM Adapter *66*

H

Handset *18*
 Handset 1 and 2 *71*
 Handset/Headset *39*
 Hardware error *89*
 Hardware Version *83*
 Head room *53, 117, 122*
 Headset *18, 116*
 HOLD *30, 39*
 Hold Signal *51*
 HOLD signal duration *51*

HOLD signal source *51*
 Homepage *35, 128*
 Hook Flash Duration *66*
 Hotline *128*
 Humidity *123*
 Humming *21*

I

I.430 *121*
 IEC-958 *122*
 Ignition *18*
 Impedance *66, 122*
 Import *44, 79*
 Incoming call *39, 57*
 Information *39*
 Input *55*
 Input level *122*
 Install Software *35*
 Installation *35*
 Interface *113*
 Internal *70*
 Inverted *58*
 IP Address *45, 72*
 IP connection *68*
 IP packets *68*
 ISDN *23, 28, 30, 62, 114, 121*

J

Japanese ISDN *62*
 Japanese ISDN Protocol *114*
 Jitter *68*

K

Key Tone *60*
 Keypad *17, 18*
 Keypad (9600 Baud) *61*
 Keypad (9600 Baud, None) *61*
 keypad lock *54, 60*

L

LAN interface *45*
 LAN Parameters *68*
 Language *27, 32, 60*
 layout-1 *81*
 LCA *89*
 LCD Display *98*
 LCD display *125*
 Length of internal telephone numbers *63*
 Level *30, 53*
 Level In *71*
 Level meter *42, 98*
 Level Out *71*
 Line *30, 31, 55, 56*
 Line 1 *55, 56*

Line 2 *55, 56*
 Line clock *29*
 Line Interface *61*
 Line Mode *62*
 Line Type *42, 62, 64*
 Load *33*
 Load Preset *43, 56*
 Local Settings *81*
 Lock *27, 39*
 LOCK ALL *38*
 Lock Line *100*
 LOCKED *100*
 Login *77, 103*
 Loop-Break Timeout *66*

M

MAC Address *83*
 MAGIC AC1 *19*
 MAGIC DC7 *19*
 MAGIC TH2plus Dual 19“ Mounting Kit *15*
 MAGIC TH2plus Keypad *18, 21, 23, 24, 46, 61, 97*
 MAGIC TH2plus PC Software Licence *73*
 MAGIC TH2plus Software *18, 21, 23, 24, 27*
 MAIN EEPROM *90*
 Main menu *103*
 Main Nominal Level of XLR Audio 1 and 2 *71*
 Mains Frequency *19*
 Mains Voltage *19*
 Male *39, 42*
 Manage Presets *78*
 Measure Values *66*
 Medium *53*
 Menu *54, 60, 103*
 Menu language *27*
 Menu structure *27, 103*
 Mounting Brackets *19*
 MSN *64*

N

Name *38, 49*
 Names *32, 103*
 National-1 *114*
 Navigation *20*
 Negative *39, 42*
 Negative edge *55*
 Neutral *39, 42*
 New *33, 78*
 New Entry *32*
 Noise *122*
 Not used *49*
 Number *38, 74*
 Number types *54*

O

Off *52, 53*
 On *52, 53, 60*
 ON AIR *17, 30, 39, 51, 58*
 ON AIR Access *49*
 ON AIR Conference *49*
 One Fader *48*
 Only one channel *49*
 Operating Mode *21, 47*
 Operation *13*
 Operation settings *103*
 Options *83*
 Order numbers *126*
 Outgoing call *40*
 Output *55, 57*
 Output level *122*
 Outside Line *62*

P

PABX *62, 64*
 Packet loss *69*
 Packet size *69*
 Password *76, 84, 103*
 Pause between repetition *51*
 PBX *63*
 PC (1152000, None) *61*
 PC (19200 Baud, None) *61*
 PC (38400 Baud) *61*
 PC (38400 Baud, None) *61*
 PC (57600, None) *61*
 PC control via RS232/Keypad 2
61
 PC OFFLINE *37*
 PC Offline *37*
 PC ONLINE *37*
 PC Online *37*
 PC ONLINE ALARM *37*
 PC Version *92*
 PHONE *21*
 Phone Book *103*
 Phone Number *55*
 Phone Number Names *54*
 Positive *39, 42*
 Positive edge *55, 57*
 POTS *17, 28, 62, 114, 121*
 POTS Interface
 PABX *63*
 POTS interface
 Outside Line *63*
 POTS Telephone *39, 61*
 Power Consumption *19*
 Power Supply *98*
 PRE TALK Conference *49*
 Prefix number *63*
 Preset *56, 74, 78*
 Presets *47, 77, 78, 103*
 PRETALK *30, 39, 58*
 Private Branch Exchange *63*

Progress *87*
 Protocol *121*
 Put into operation *32*

Q

Quick dial *32, 74*
 Quick Dial Number *30*
 Quick Menu *27*

R

Receive *30*
 Record source *51*
 Recorded Hold Signal *39, 51*
 Recovered *70*
 Redialling *31*
 Registration *35, 68, 83*
 Relay *17, 18, 119, 121*
 Relay 1 *58*
 Relay 2 *58*
 Relay output *58*
 Relays *55*
 Repairs *128*
 Repetition *51*
 Reset DTMF *43, 94*
 Resolution *20, 123*
 Right to Left Layout *81*
 Ringing/Connected State *58*
 RJ12 *121, 122*
 RJ45 *121*
 RS232 *17, 23, 24, 119, 121*
 RS232 interface *46, 61*

S

S0 *121*
 S0 Interface *114*
 Safety *123*
 Sample Rate Converter *18, 29,*
70, 122
 Save *33, 51*
 Save as Quickdial *32*
 Save settings? *27*
 Screener.mdw *54*
 Search *31, 32*
 Select *27, 79*
 Select Caller *40*
 Serial cable *36*
 Service *86*
 Set AGC on/off for all lines *52,*
53
 Set Audio Line *56*
 Set Information Base Entry *58*
 Setup *35*
 Shared *48*
 Shared Mode *38*
 SHIFT *31*
 Signal Processing *17, 52*

- Signal Processor *17*
 - Signal to Noise Ratio *122*
 - SIP Server *68*
 - Skip prefix number on incoming call *63*
 - Slow *53*
 - Softkey *20*
 - Software *27*
 - Software Download *36*
 - Software Options *84*
 - Software Updates *128*
 - Special Characters *78*
 - Speed *53*
 - Standard *94*
 - Standby *19*
 - Start *51, 87*
 - Status information *103*
 - Status Window *30*
 - Stop *51*
 - Storage *13*
 - STUN Server *68*
 - Subject Number *83*
 - Subnet Mask *72*
 - Subnetz *72*
 - Support *86, 128*
 - Switch current *57*
 - Switch voltage *57*
 - synchronous *70*
 - System alarm *89, 90*
 - System Database *54*
 - System Monitor *77, 89*
 - System Name *61*
 - System Panel *86*
 - System Settings *27, 29, 44*
 - System settings *103*
 - System Temperature *19, 90*
- T**
- TCU-100 *66*
 - TCU-121 *66*
 - Telephone Book *30, 41, 54*
 - Test *51*
 - th2.ssw *87*
 - Threshold *19, 53*
 - TIME KEEPER *89*
 - Transmit *30*
 - Transport *13*
 - TTL *17, 18, 55, 57, 93, 119, 121*
 - TTL Pin as input *55*
 - TTL Pin as Output *57*
 - TTL1 *55*
 - TTL2 *55*
 - TTL3 *55*
 - TTL4 *55*
 - Two Faders *48*
- U**
- Updates *128*
- USA ISDN (NI-1) *62*
 - USB Stick *79*
 - Use DHCP *72*
 - Use only 1 ISDN line *49*
 - Use only 1 POTS line *49*
 - Use only 1 VoIP line *49*
 - Use STUN *68*
 - User *76, 103*
 - User busy *99*
 - User Rights *76*
 - Using External Phone as Pretalk Interface *39, 61*
- V**
- Ventilation *19*
 - Version *92*
 - View *32*
 - VoIP mode *68*
 - Volume Control *53*
- W**
- Wait for received phone number (CLIP) before call in signalling *66*
 - Warm start *84*
 - Weight *123*
 - Western socket *21*
 - Word clock *117*
- Y**
- Year *83*

CE-Konformität

DECLARATION OF CONFORMITY

Name des Anbieters: AVT Audio Video Technologies GmbH
Supplier's name:

Anschrift des Anbieters: Nordostpark 12
Supplier's address D-90411 Nürnberg

erklärt, daß das Produkt
declares, that the product

Produktname(n): MAGIC TH2plus Telefonhybrid 802000
MAGIC TH2plus RM Telefonhybrid 802005
Product name(s): MAGIC TH2plus Telephone Hybrid 802000
MAGIC TH2plus RM Telephone Hybrid 802005

mit den Vorschriften folgender Europäischer Richtlinien übereinstimmt:
conforms to the standards of the following European directives:

Nummer/Text: EN 60950 A4 Gerätesicherheit
Number/title:

Die Übereinstimmung wird nachgewiesen durch vollständige Einhaltung folgender Normen:
The conformity is evidenced by strictly meeting the following standards:

Harmonisierte Normen: EN 55022, EN 55024,
Harmonized Standards: EN 300386,
FCC Part 15 B

Ort, Datum: Nürnberg, 07.12.2010
Place, date:

Name(n): Wilfried Hecht
Name:

Rechtsverbindliche Unterschrift(en):
Legally binding signatures:



Telefon: +49 911 5271-120
Phone:

Diese Erklärung beinhaltet keine Zusicherung von Eigenschaften.
This declaration includes no warranty of properties.

Die Sicherheitshinweise der mitgelieferten Produktdokumentation sind zu beachten.
The safety instructions specified in the product documentation delivered must be observed.

